

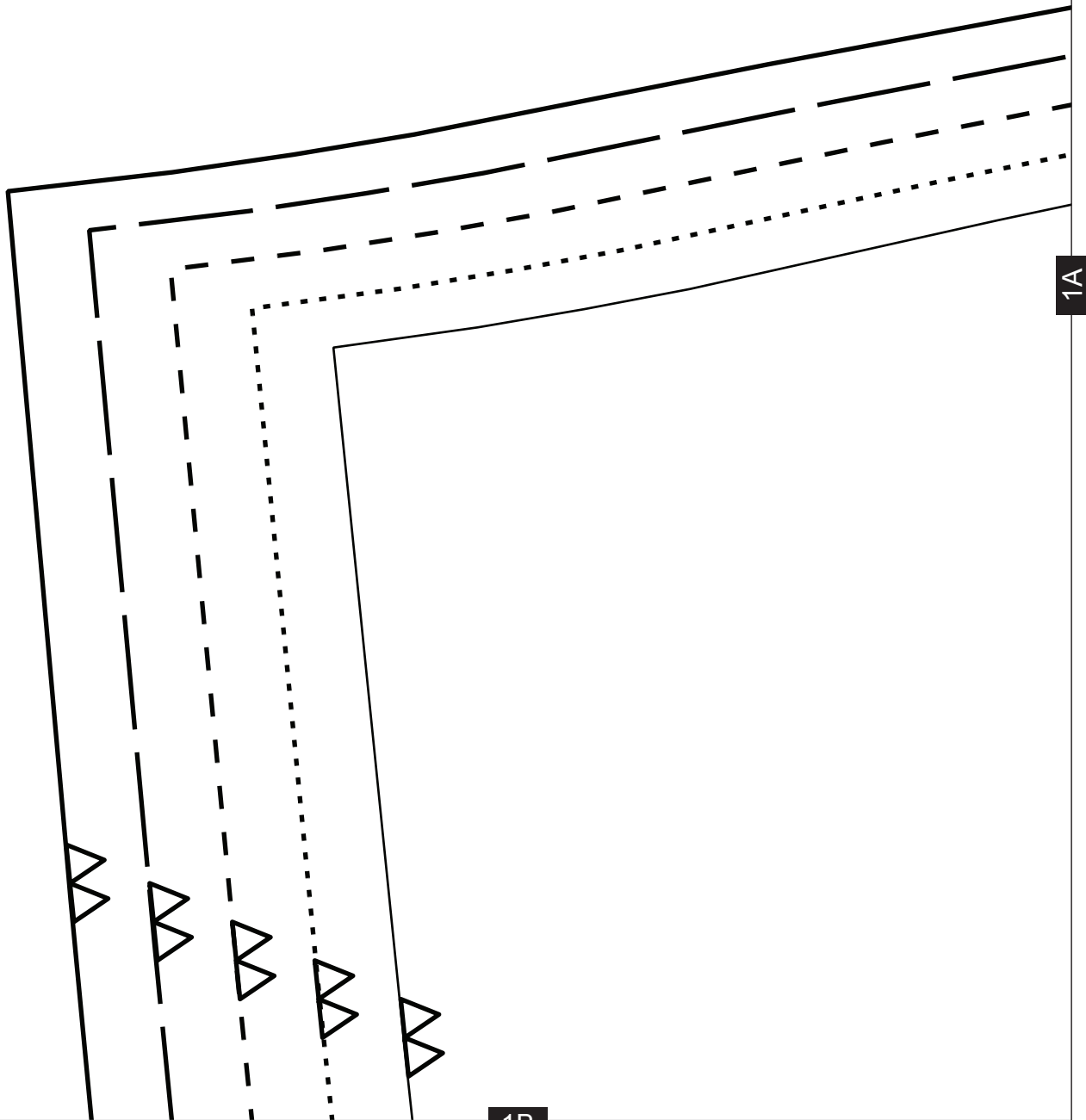

XS \_\_\_\_\_  
S .....  
M - - - - -  
L \_\_\_\_\_  
XL \_\_\_\_\_

**Drapey Knit Dress**

Project design © Love Productions 2015  
This design is protected by copyright and  
must not be made for resale.



1A

1B

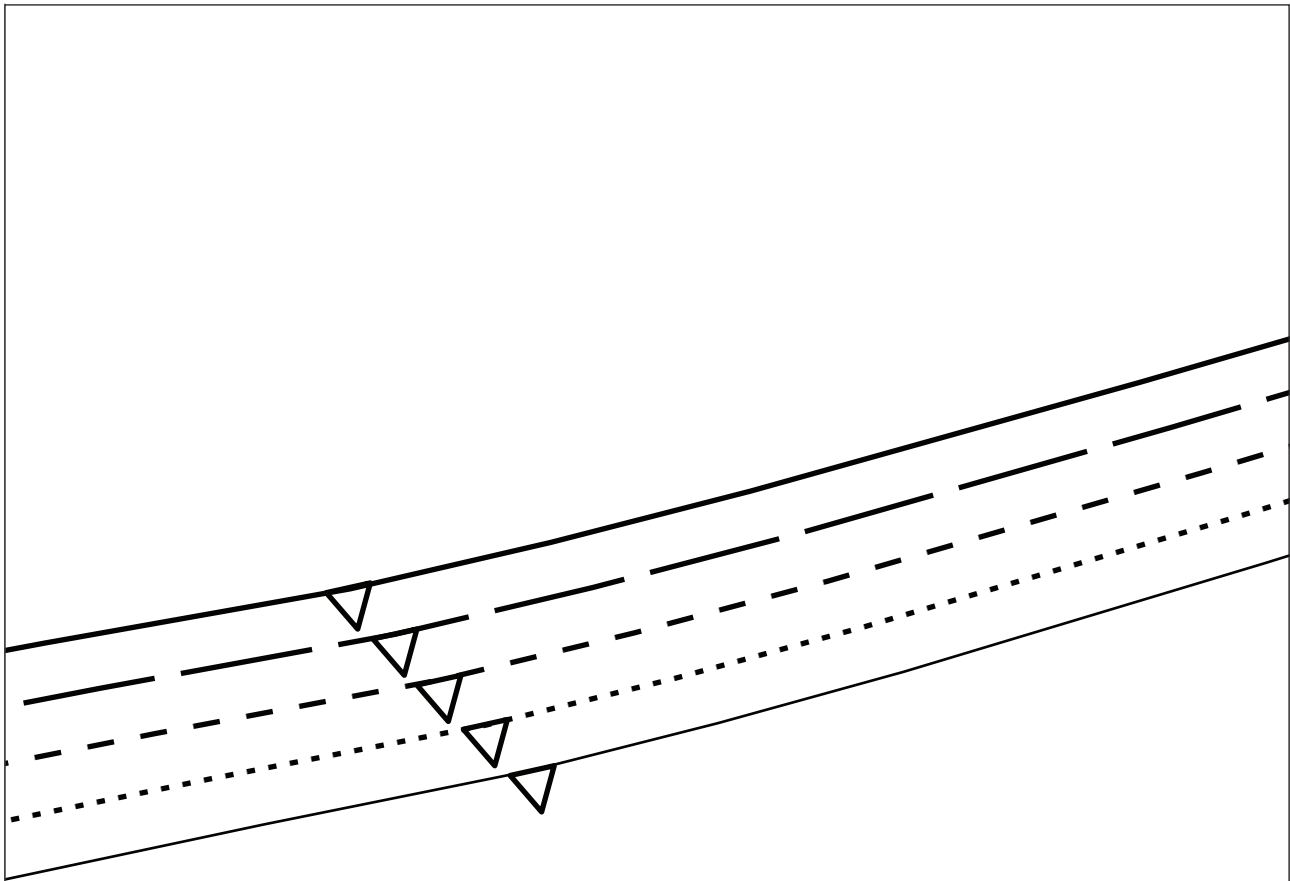

1A

2A

## DRAPEY KNIT DRESS

BACK - CUT 1 ON FOLD

2B

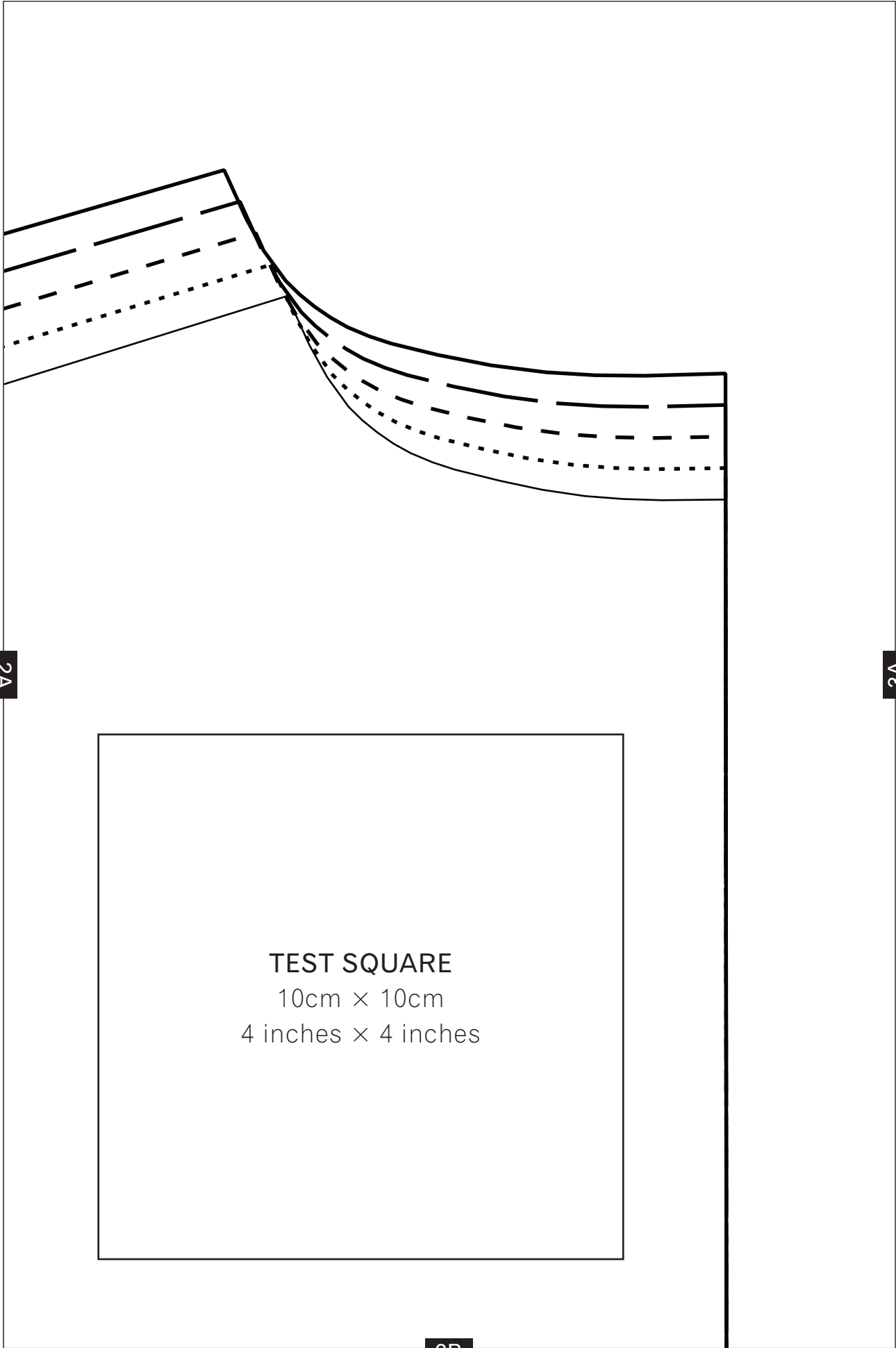

2A

3A

3B

TEST SQUARE  
10cm x 10cm  
4 inches x 4 inches

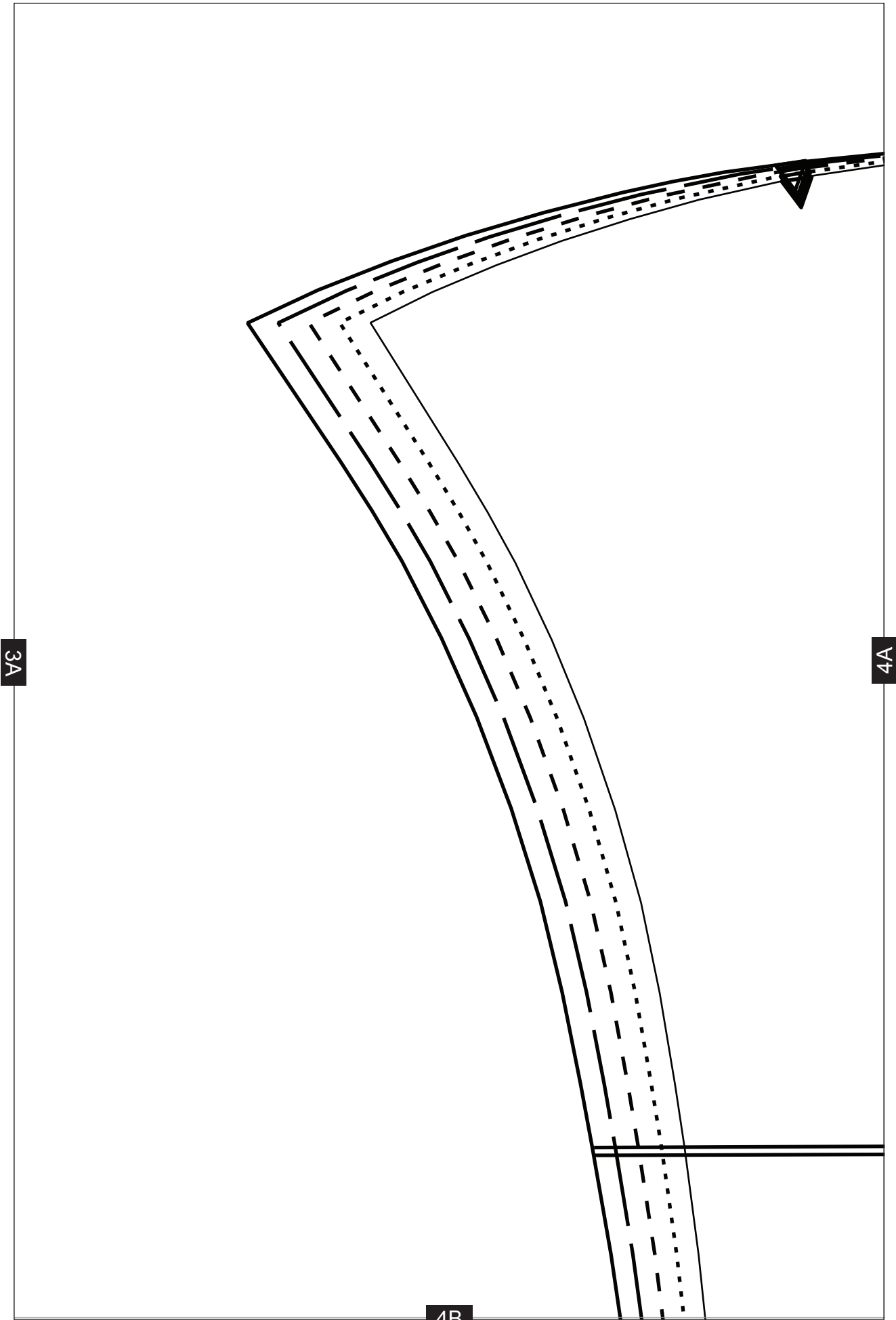

3A

4A

4B

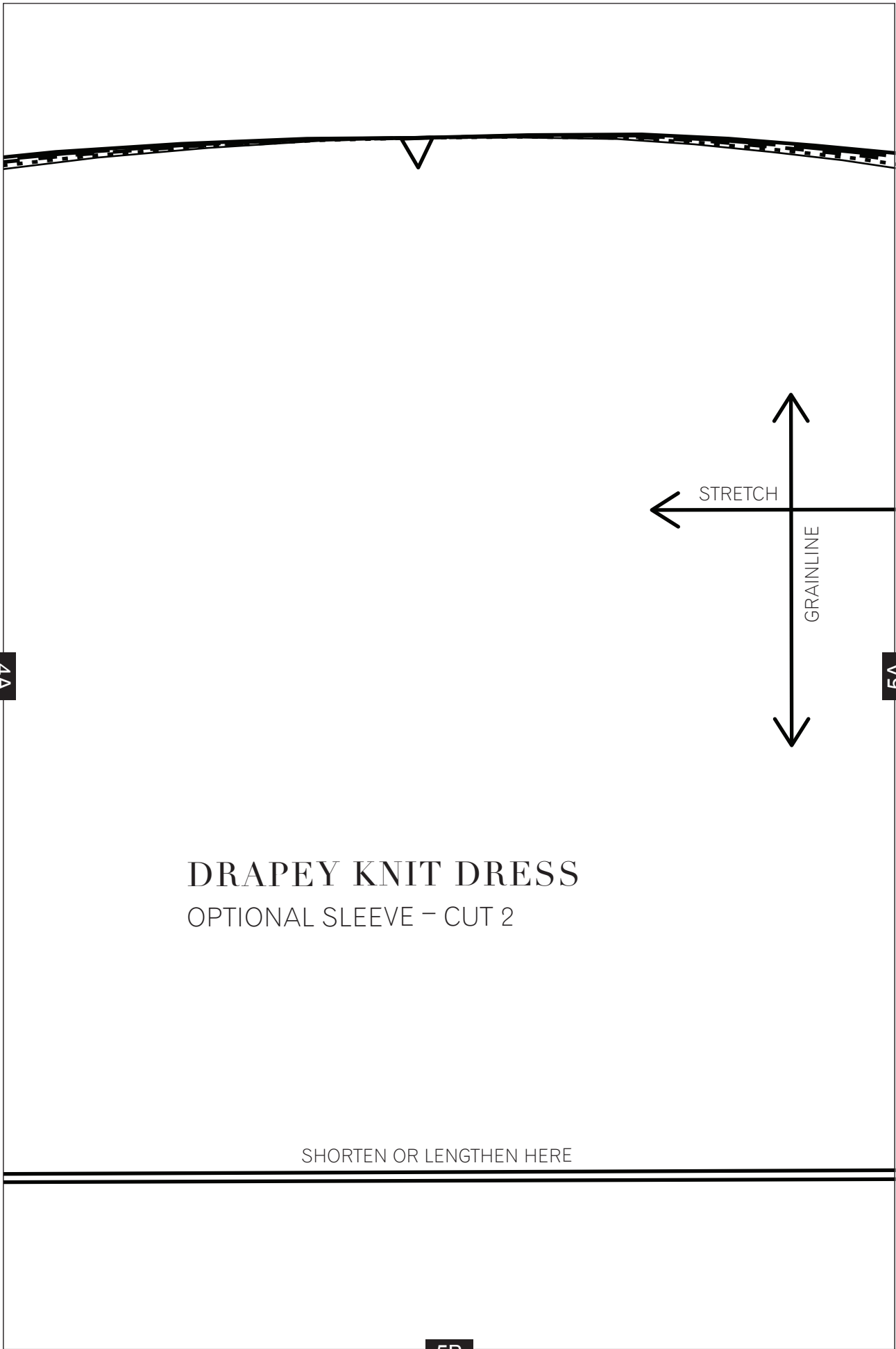

**DRAPEY KNIT DRESS**  
OPTIONAL SLEEVE – CUT 2

SHORTEN OR LENGTHEN HERE

5B

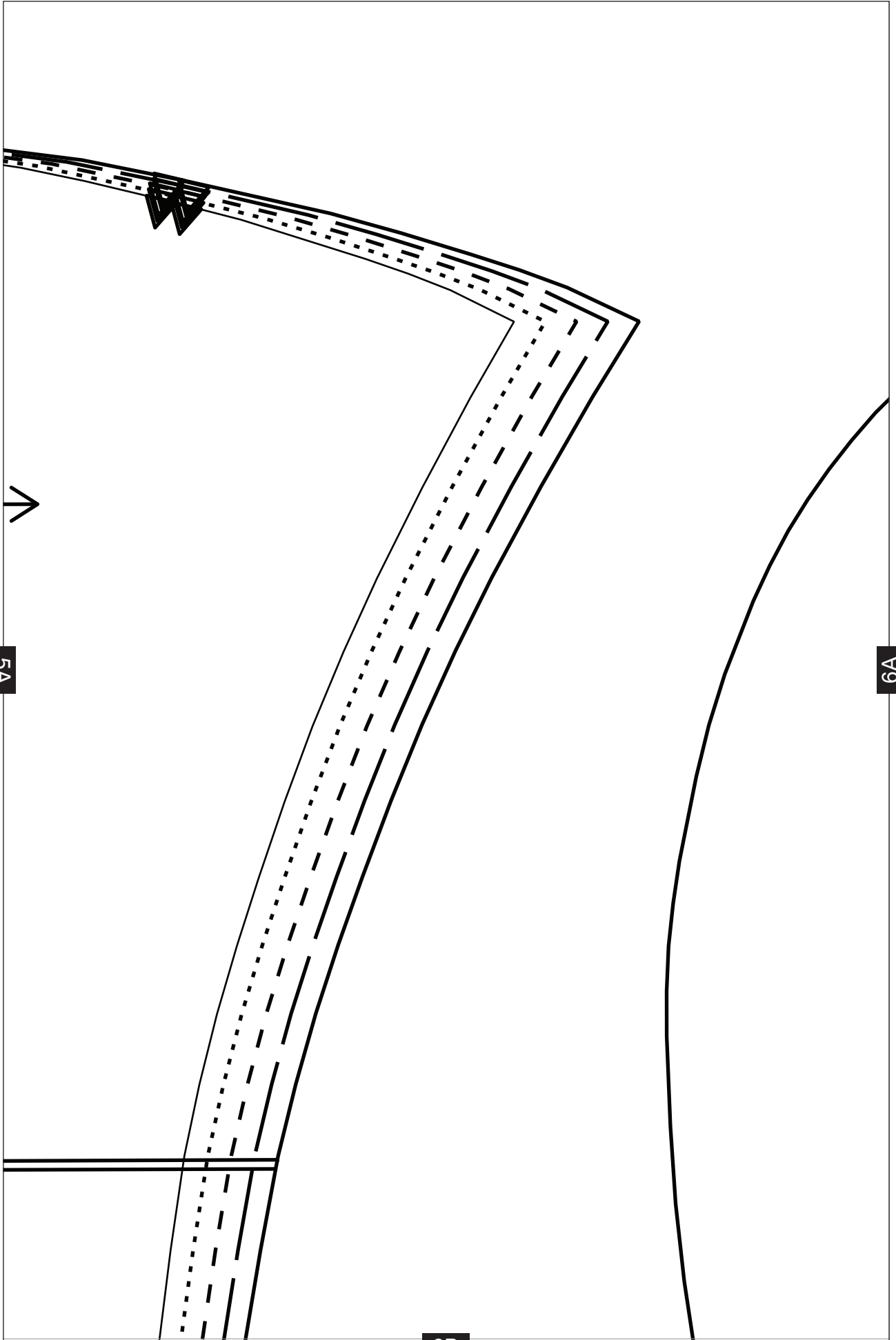

5A

6A

6B

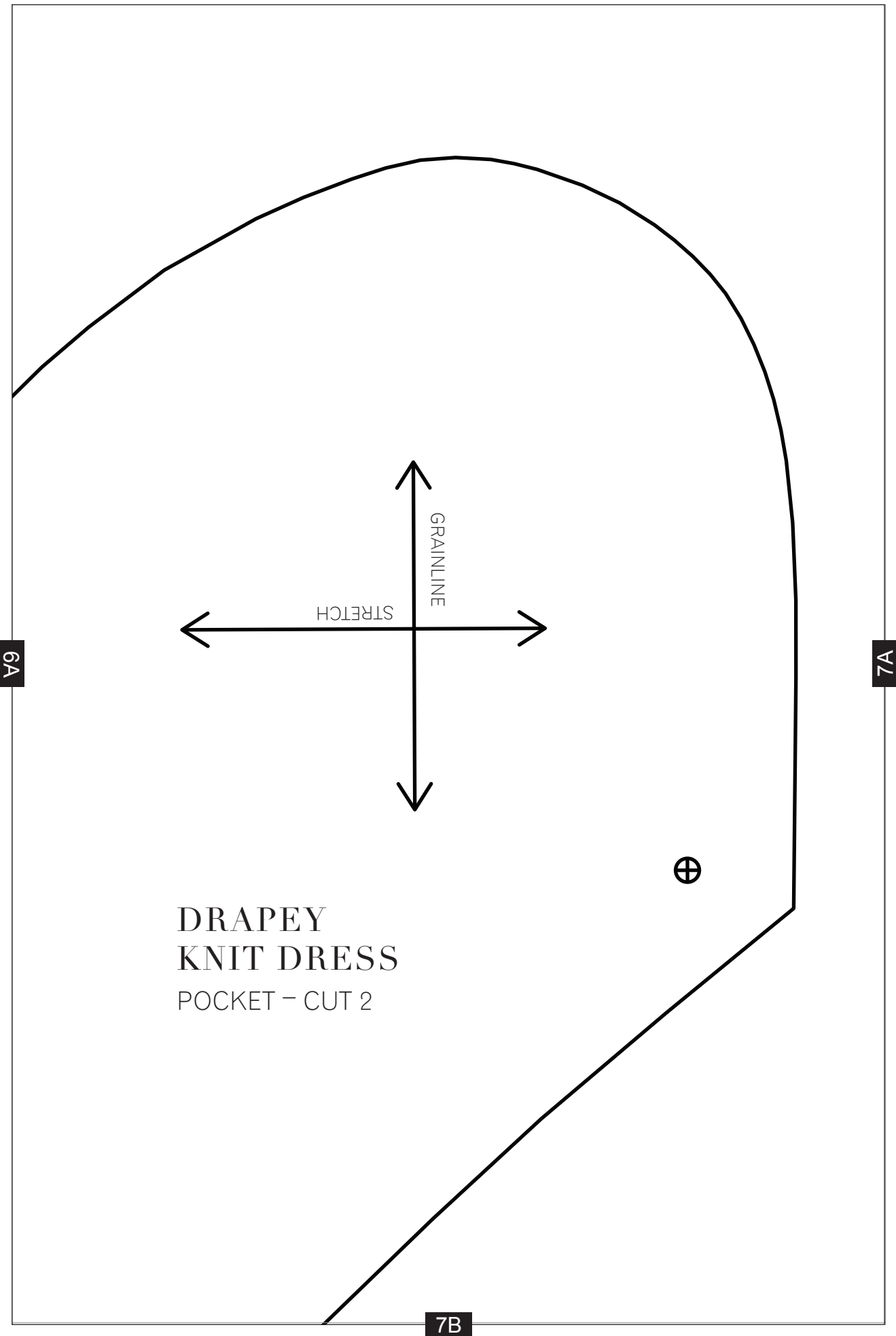

6A

7A

7B

DRAPEY  
KNIT DRESS  
POCKET - CUT 2

STRETCH

GRAINLINE



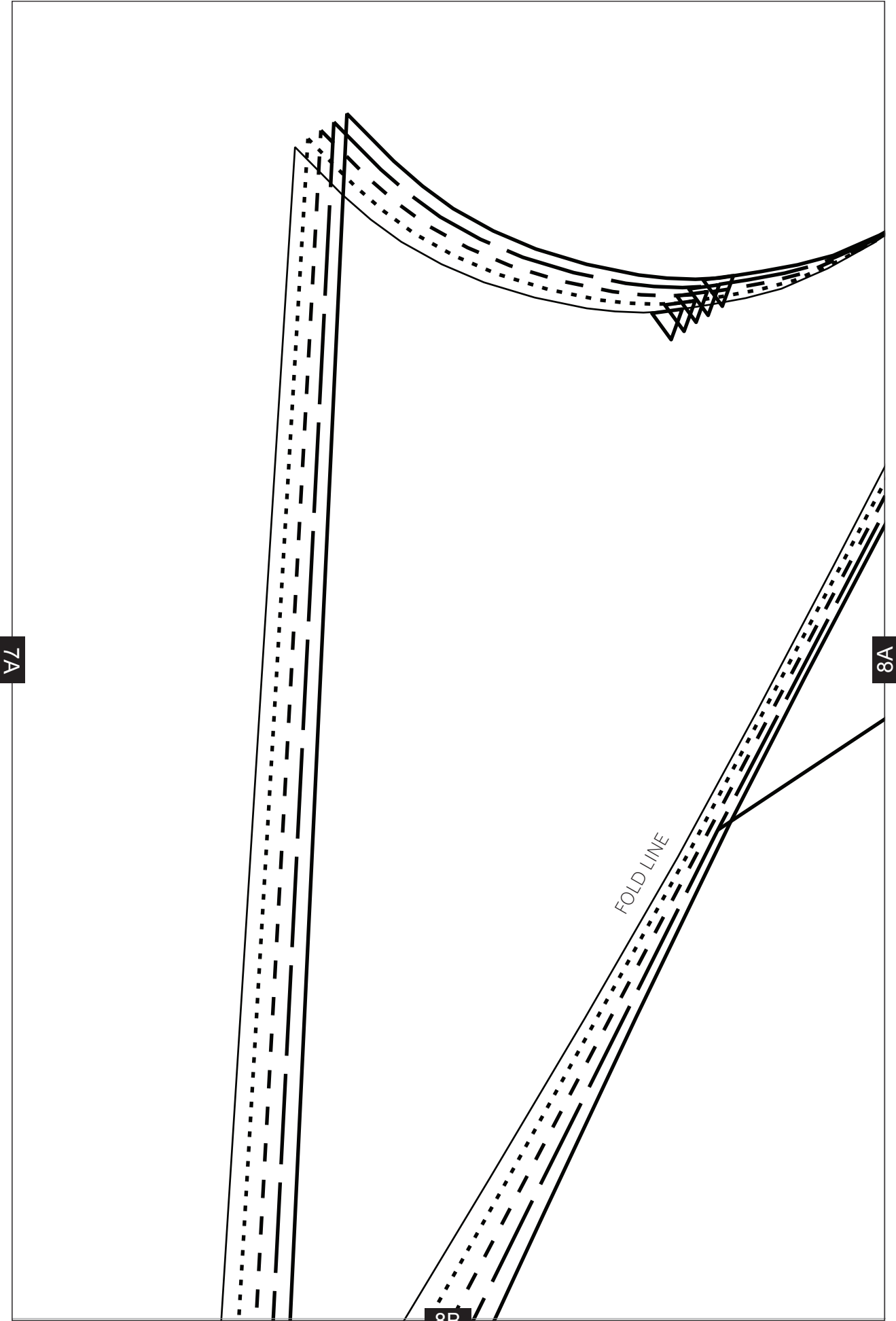



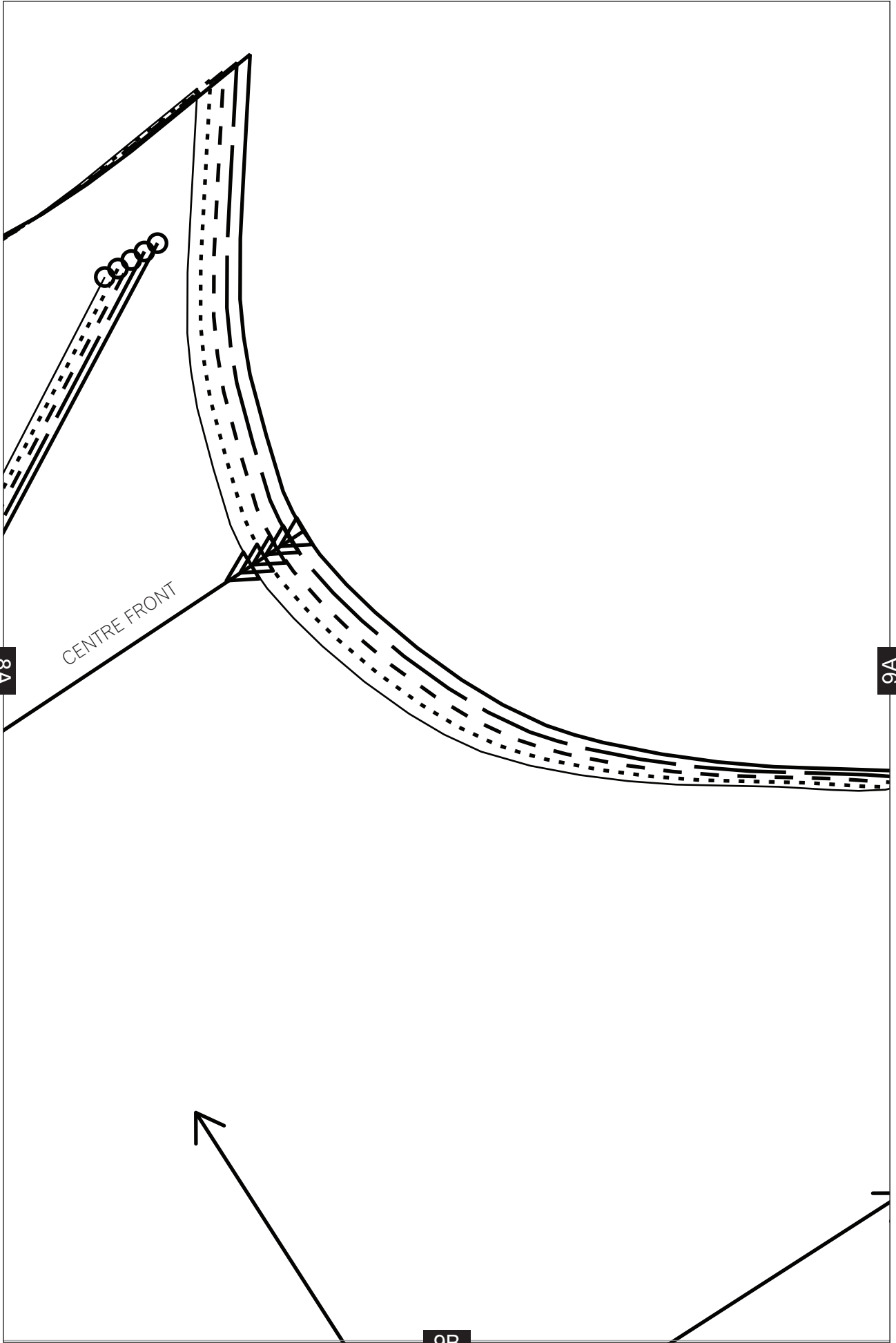

9A

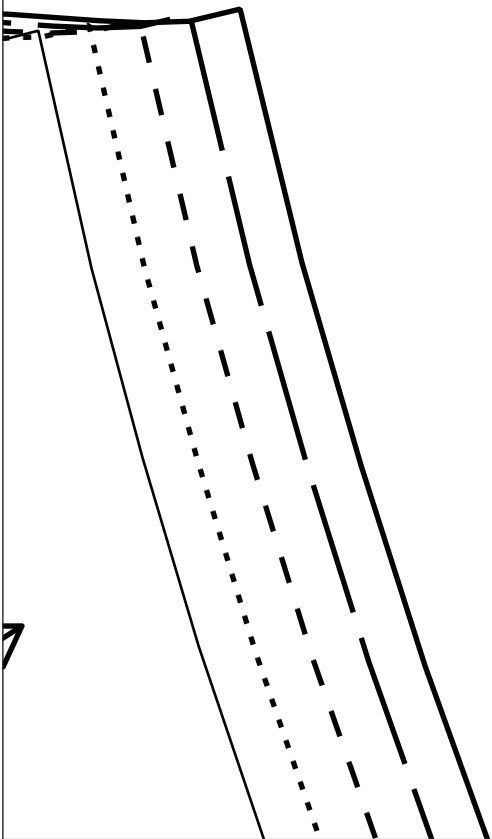

10B

1B

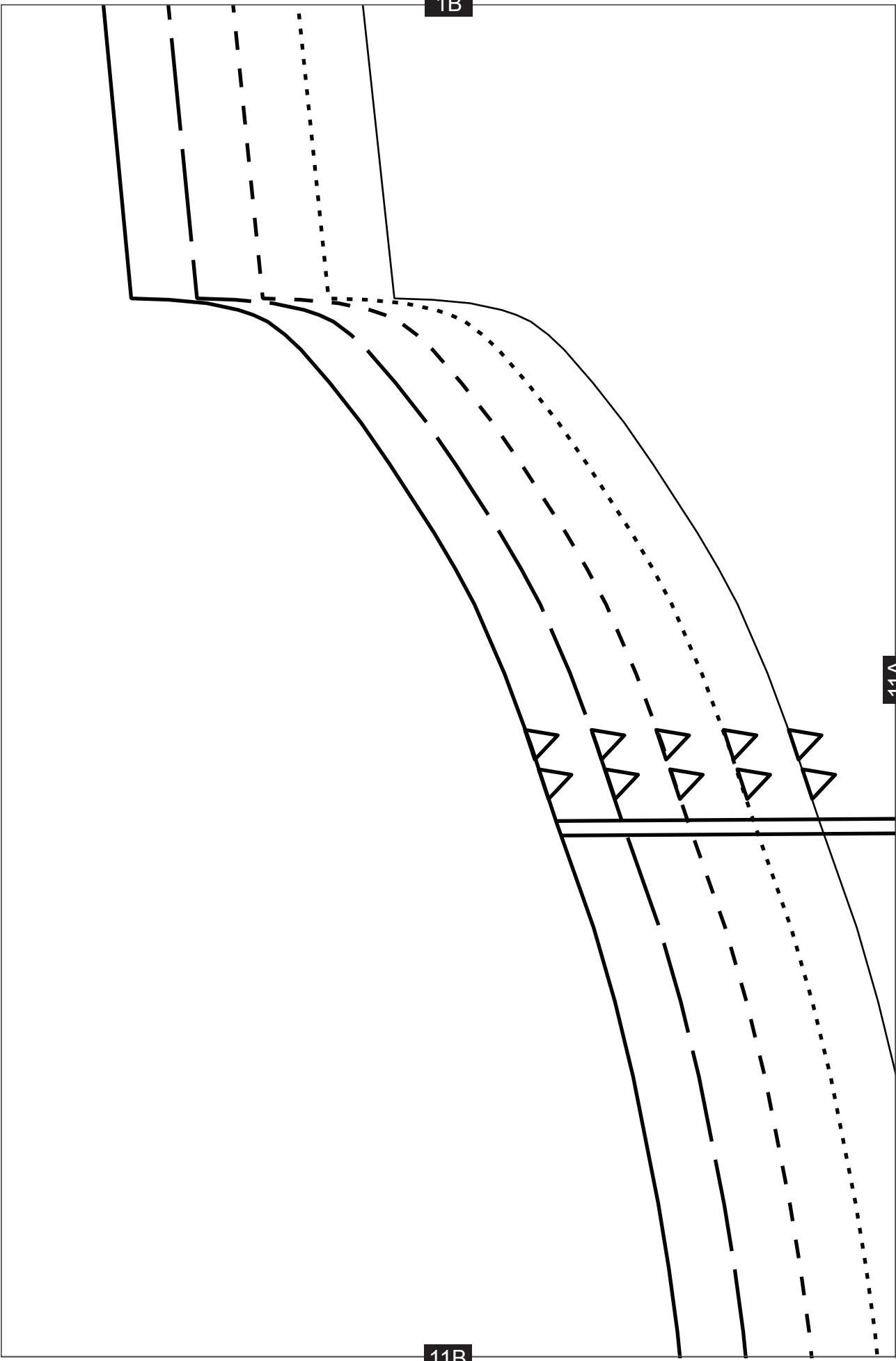

11A

11B

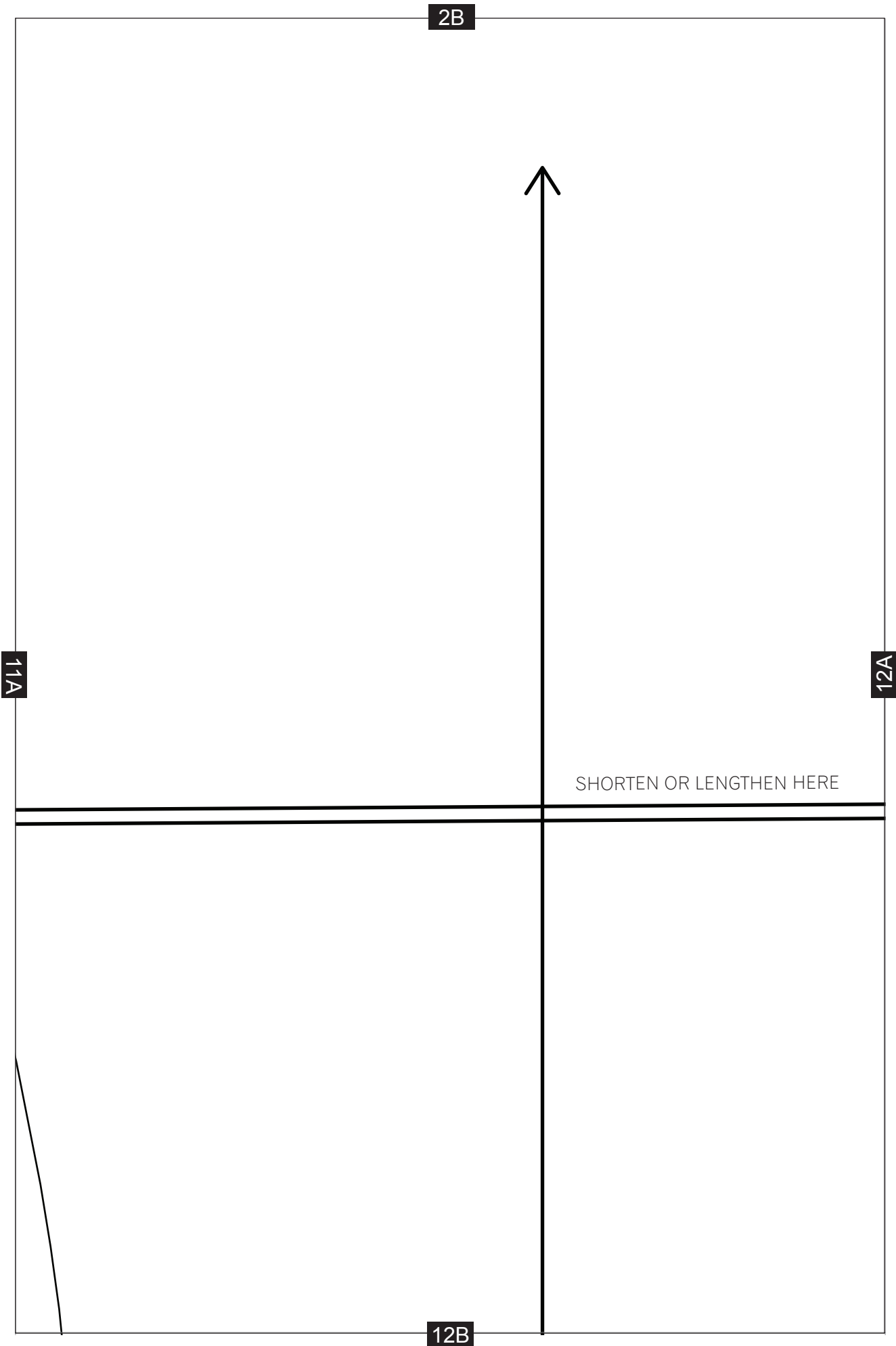

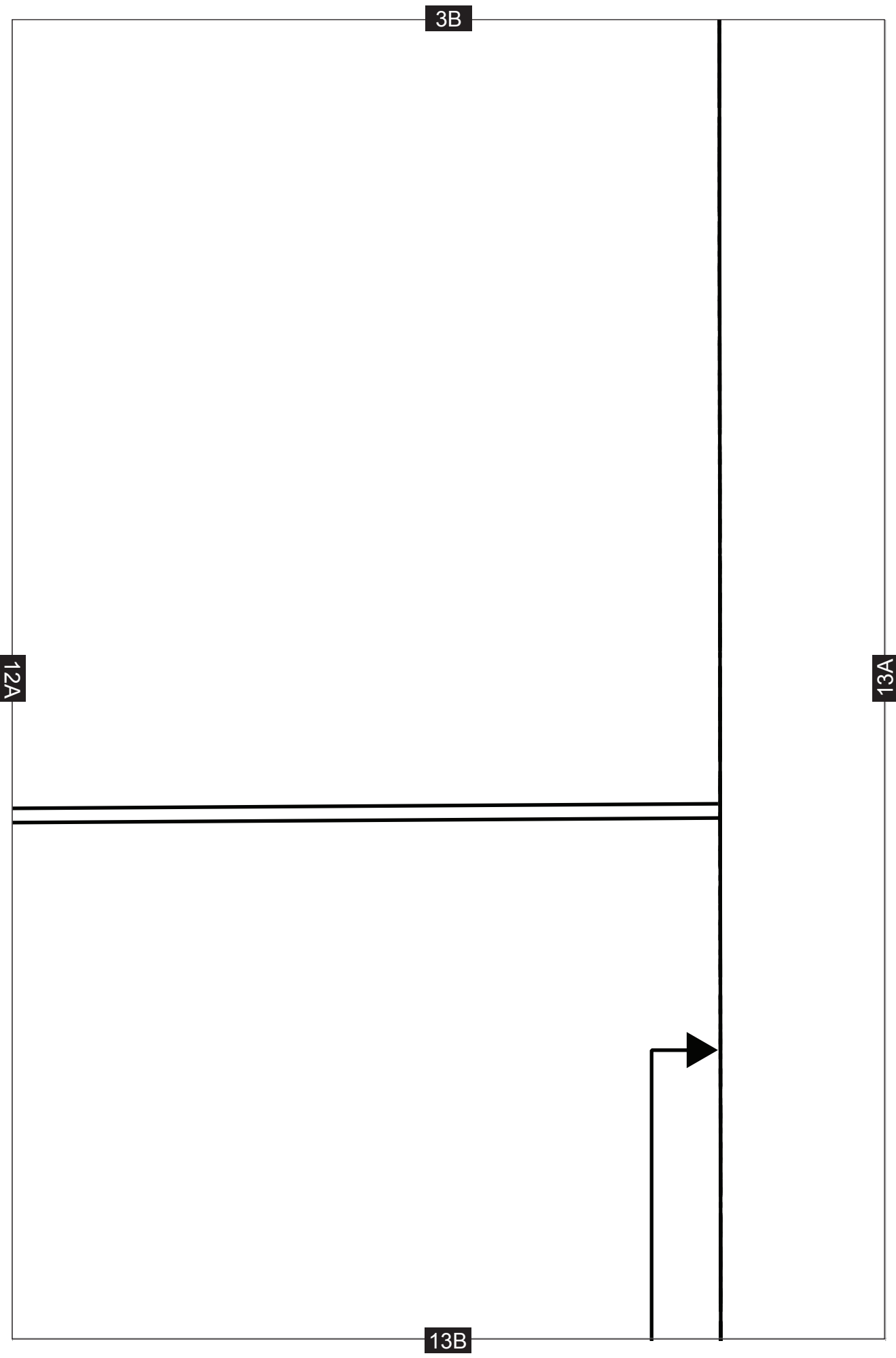

4B

13A

14A

14B

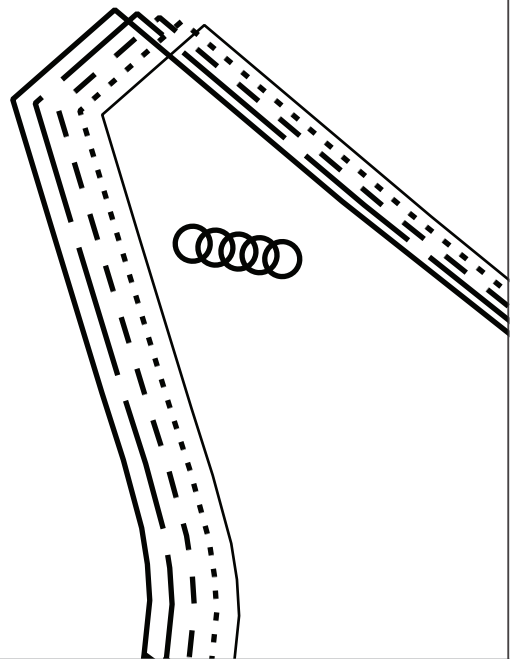

5B

14A

15A

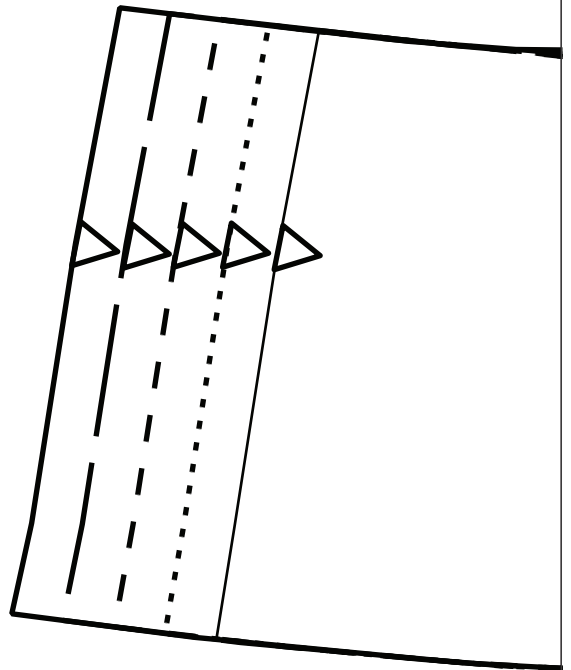
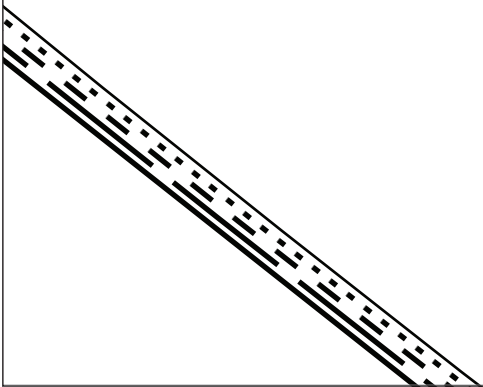

15B

6B



15A

16A

PLACE TO FOLD  
CENTRE FRONT

# DRAPEY KNIT DRESS

FRONT FACING - CUT 1 ON FOLD

16B

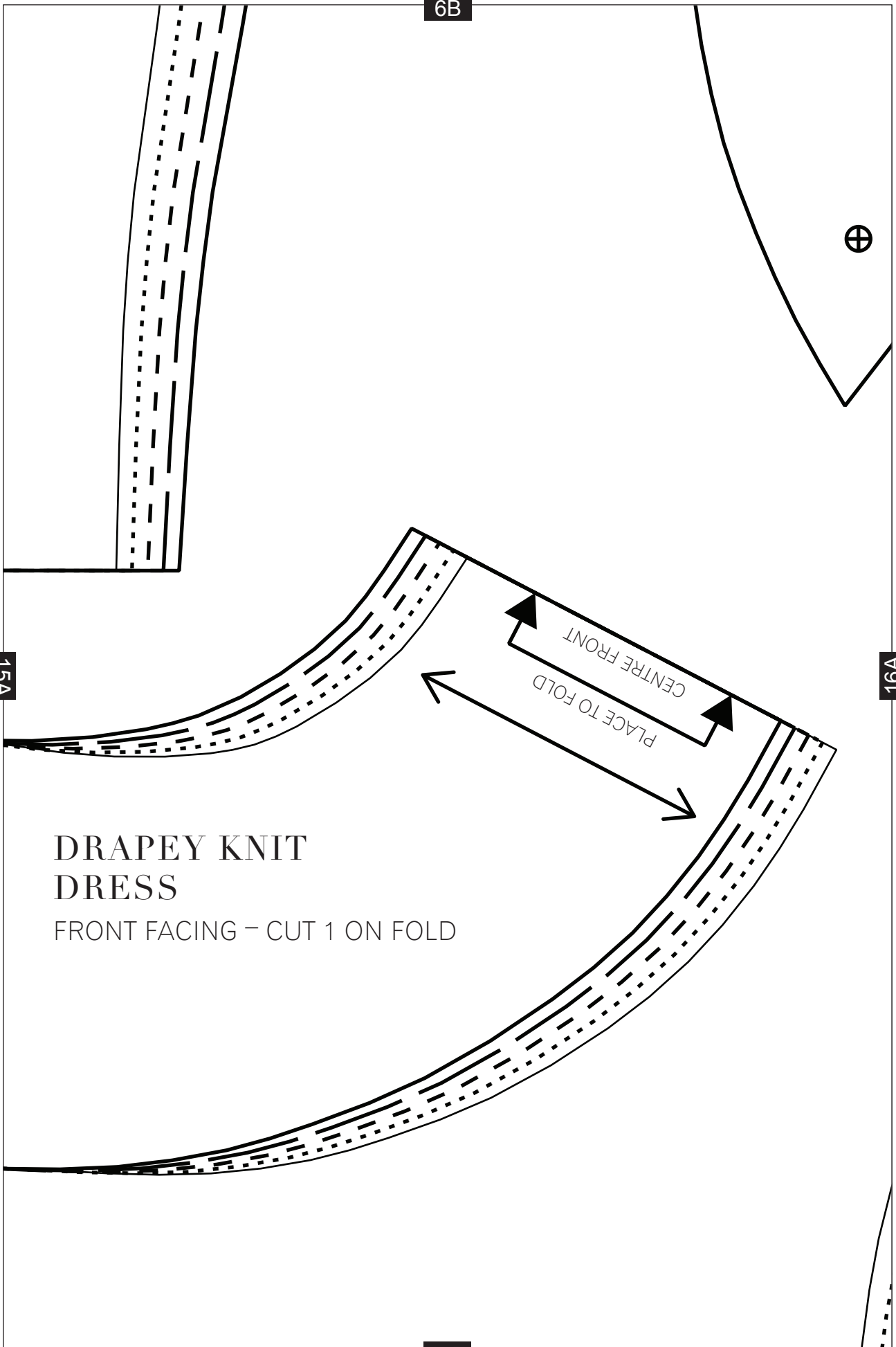



7B

16A

17A

17B

OPTIONAL CUT LINE

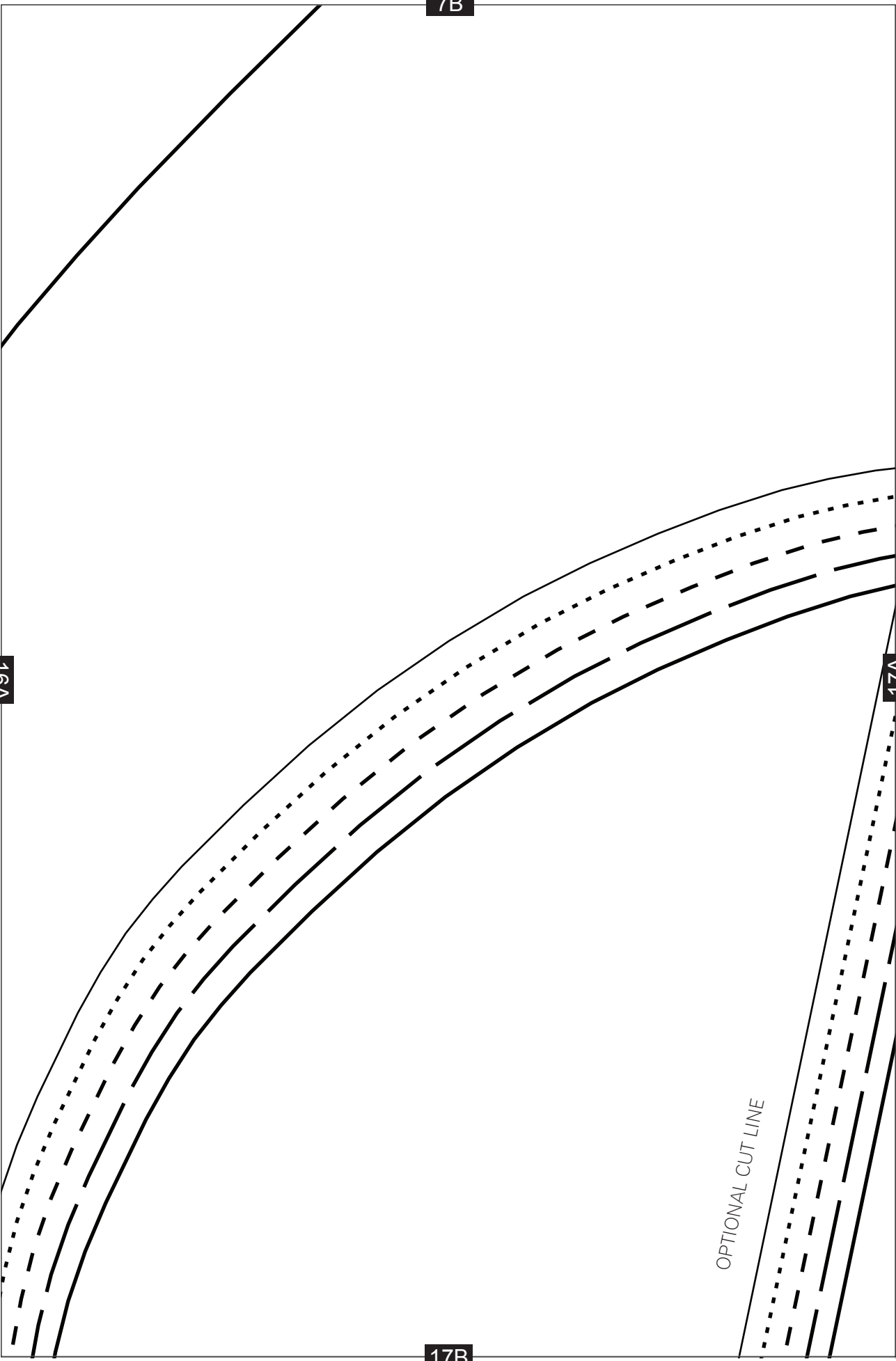

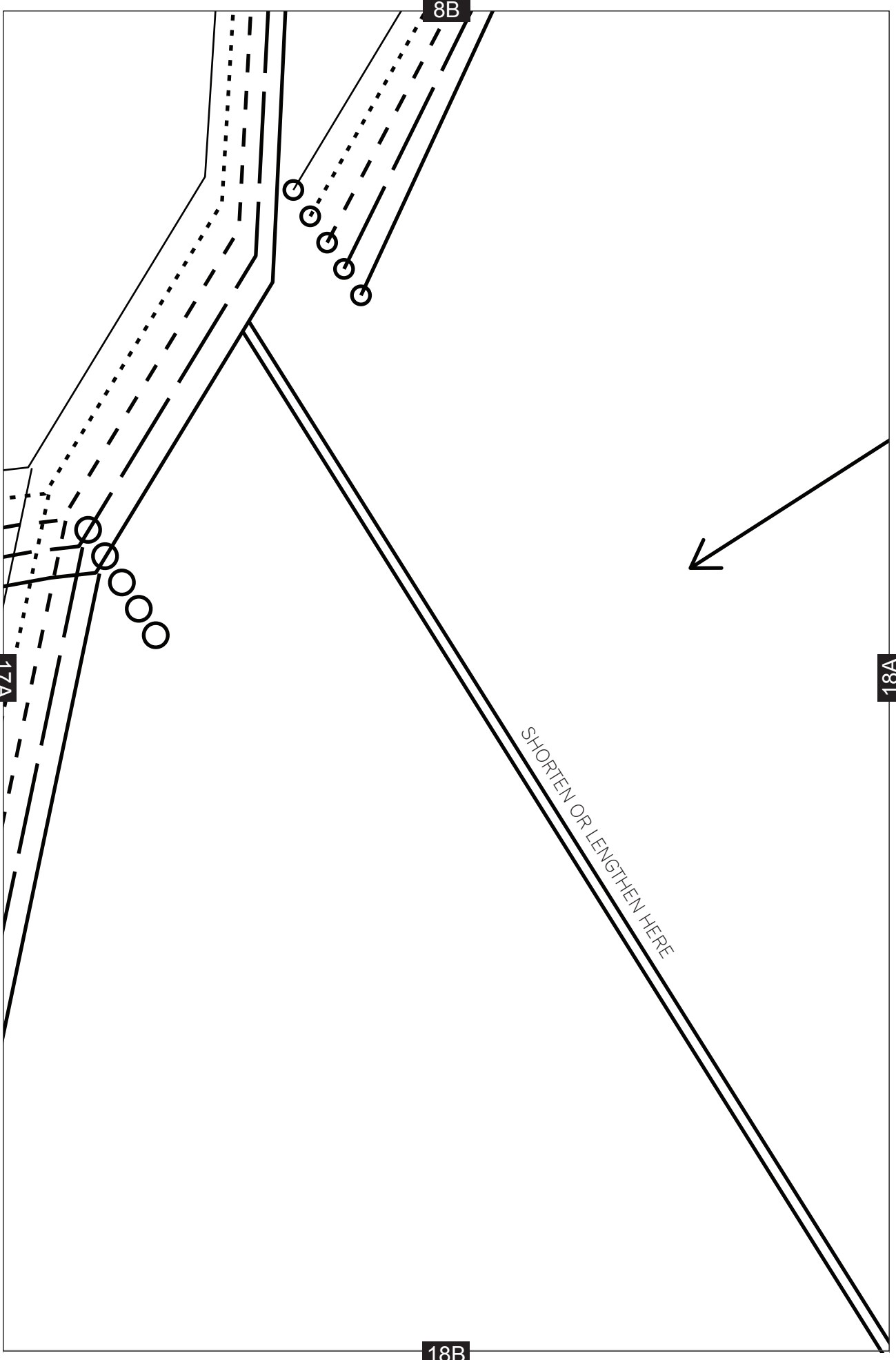

9B

STRETCH

GRAINLINE



# DRAPEY KNIT DRESS

FRONT LEFT - CUT 1

18A

19A



19B

10B

19A

20B

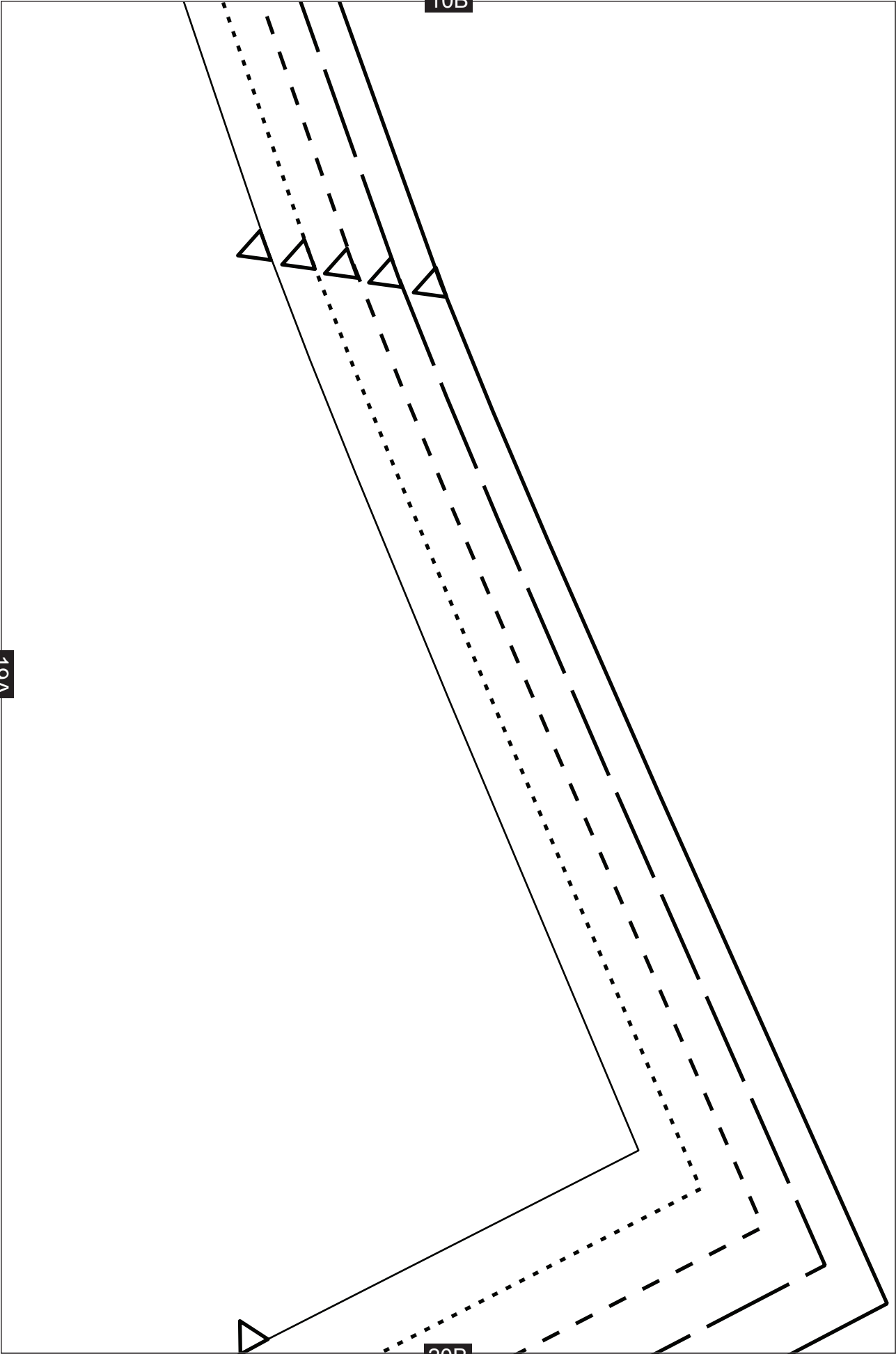

11B

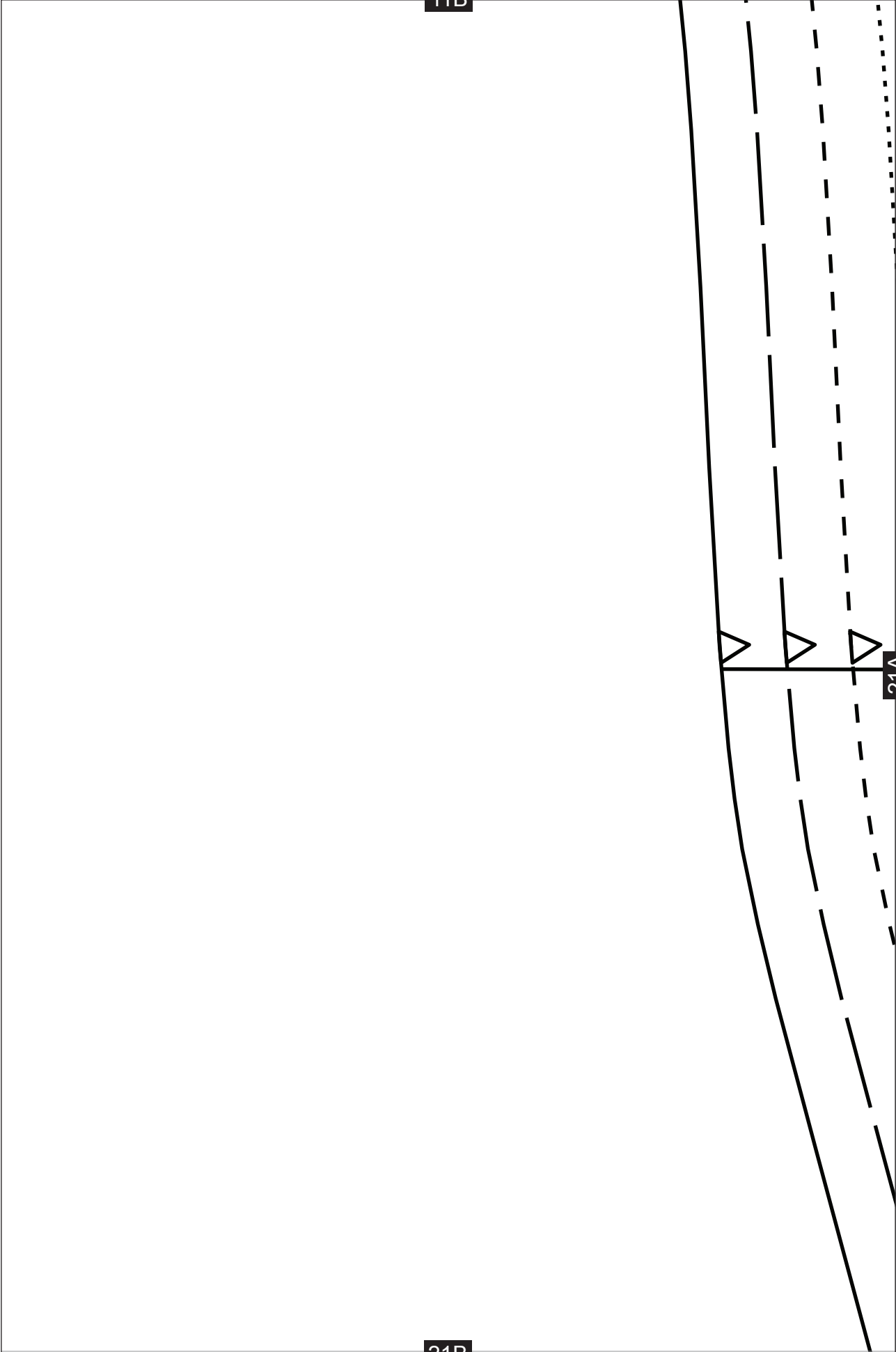

21A

21B

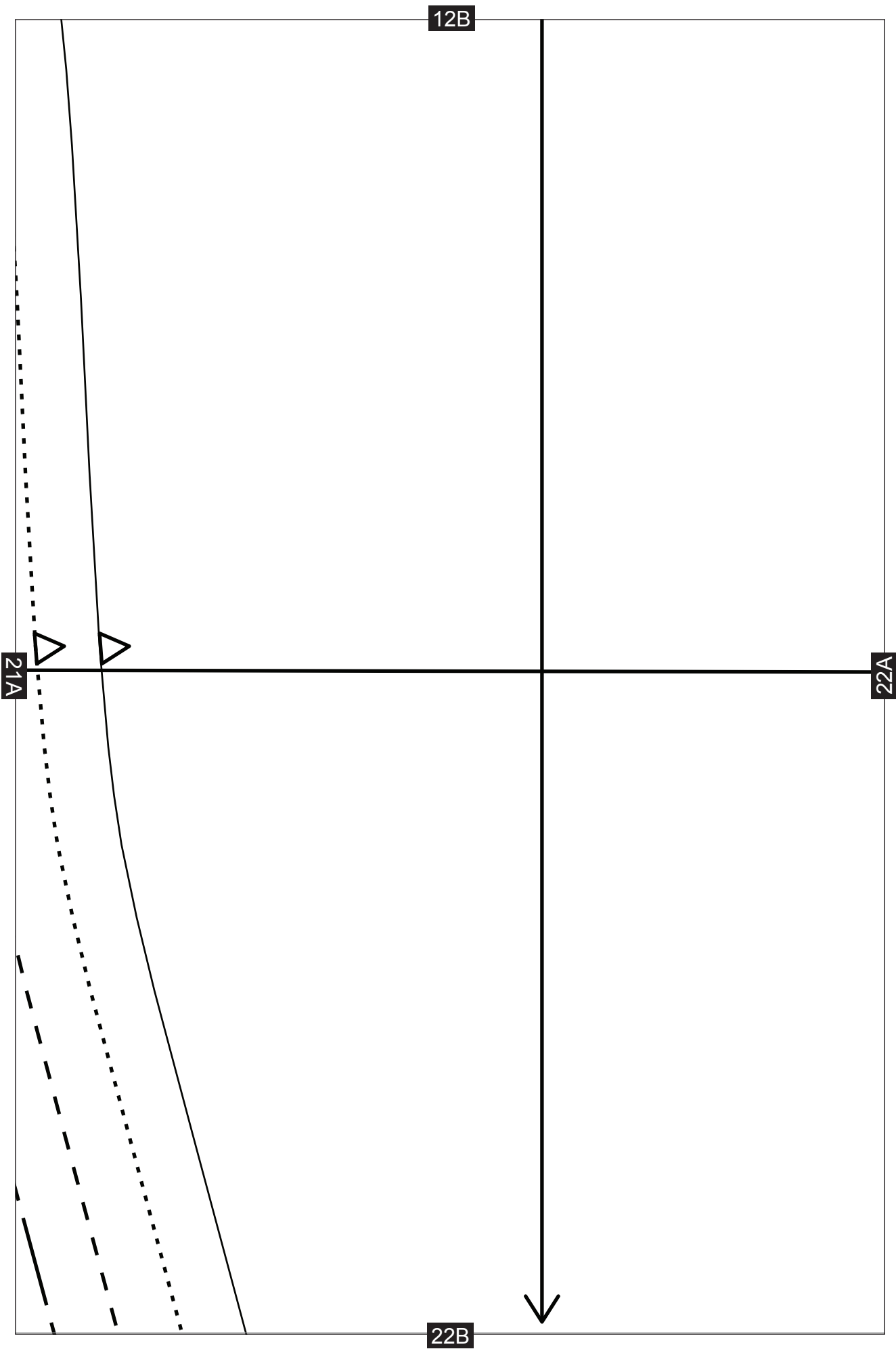

13B

PLACE TO FOLD

CENTRE BACK

OPTIONAL CUT LINE FOR SPLIT BACK

22A

23A

23B

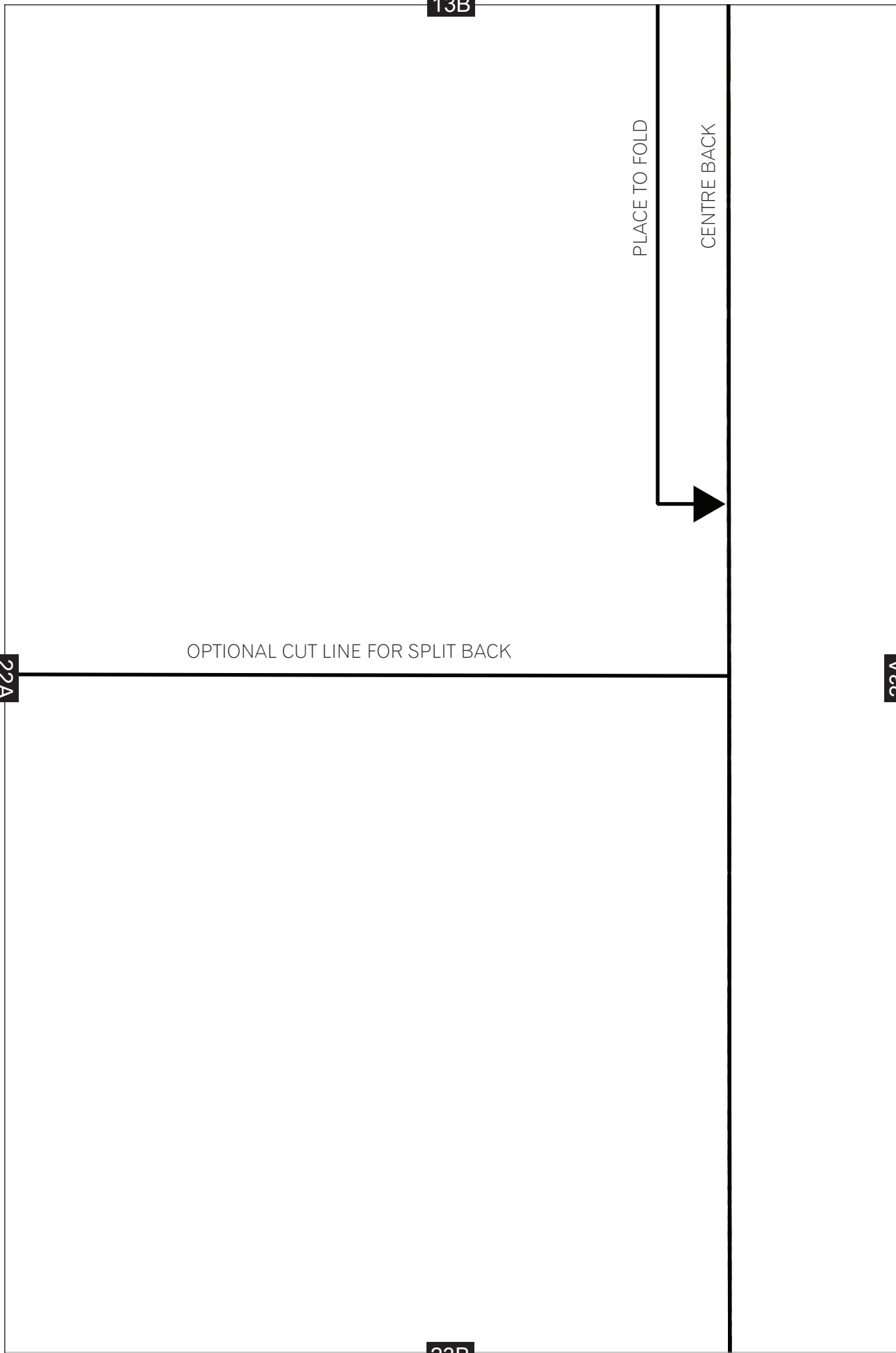

14B

23A

24A

24B

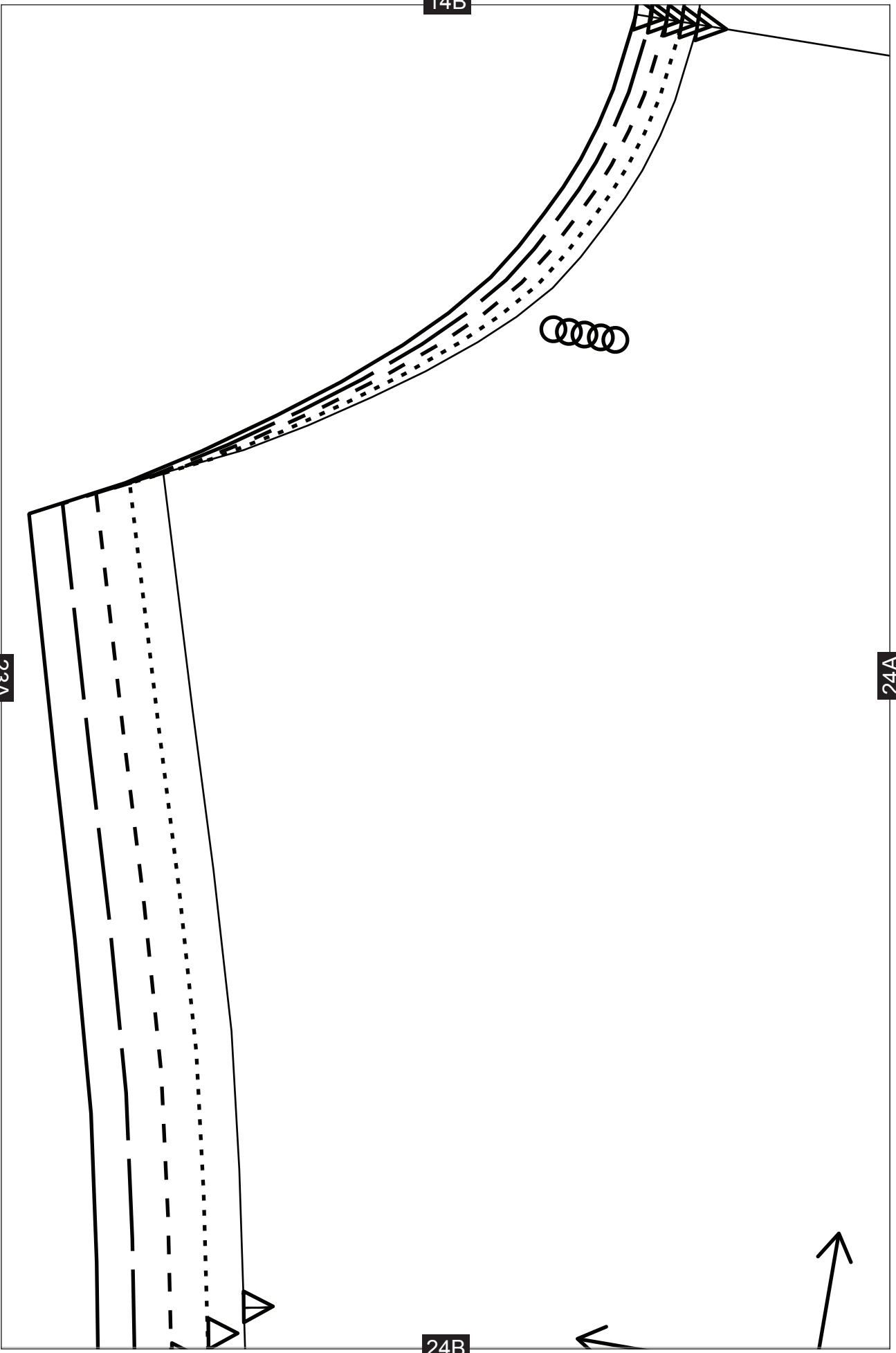



15B

CENTRE FRONT

24A

25A

# DRAPEY KNIT DRESS

FRONT RIGHT - CUT 1

25B

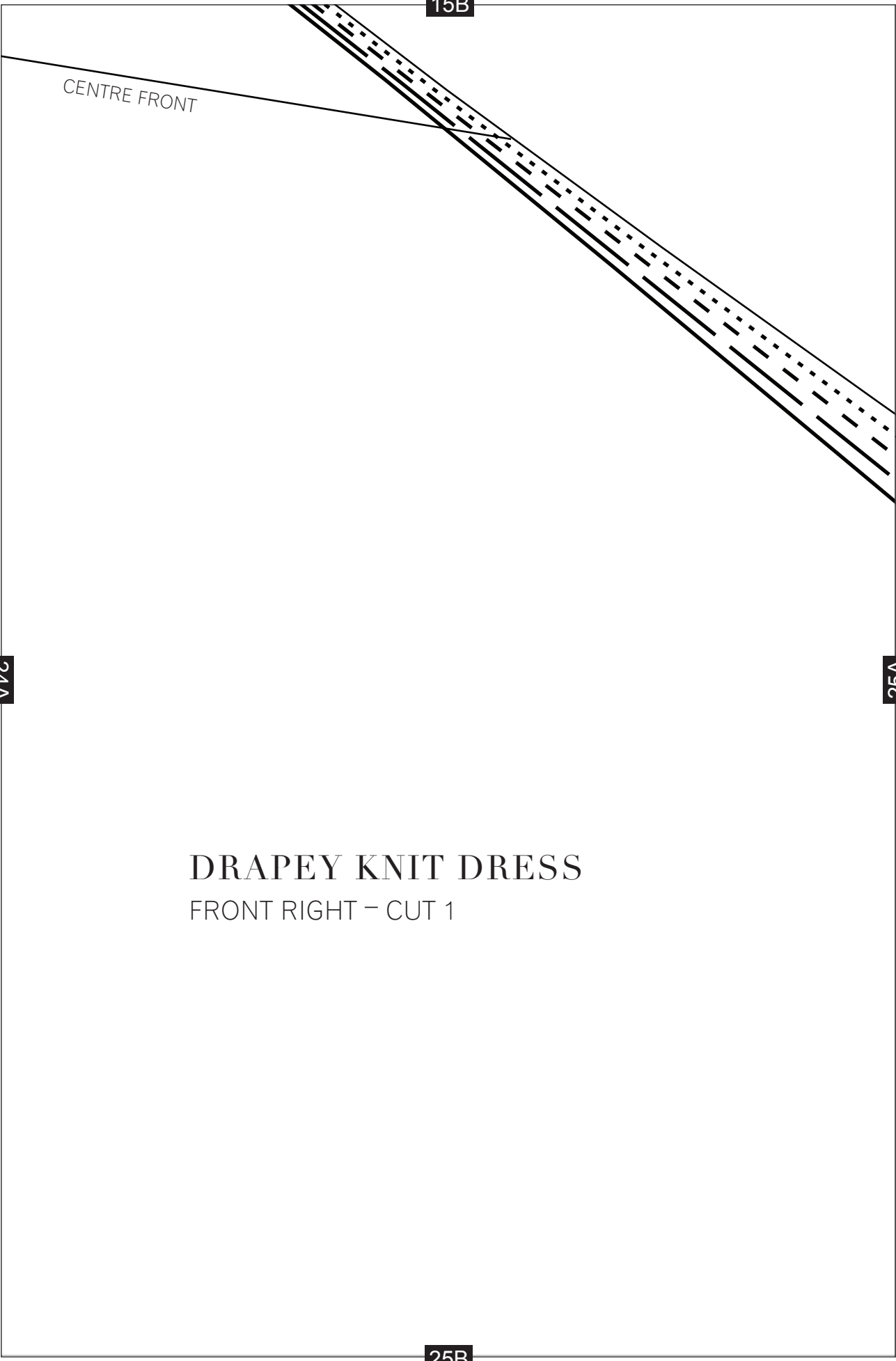

16B

25A

26A

26B

SHORTEN OR LENGTHEN HERE

OPTIONAL CUT LINE

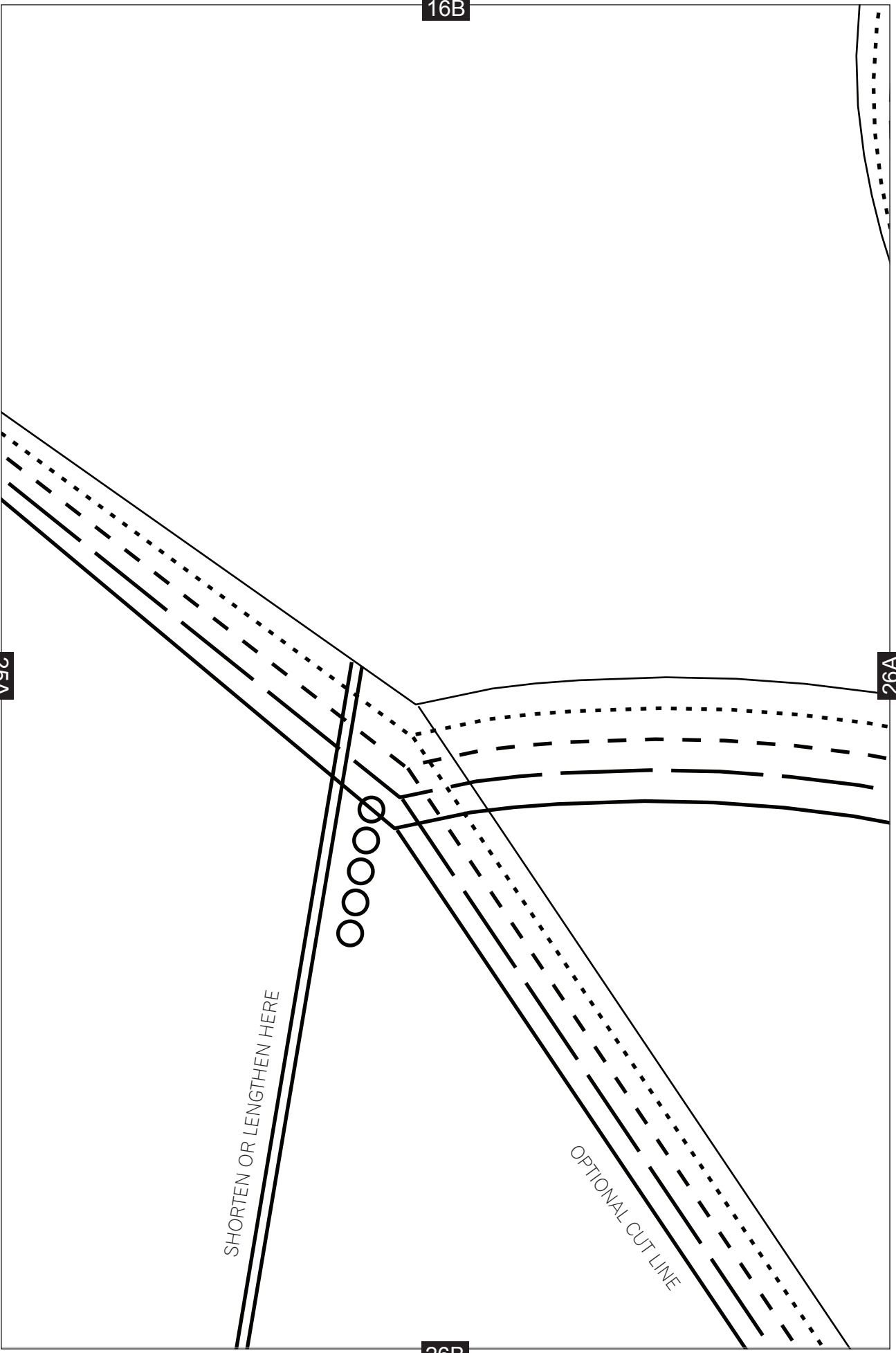

17B

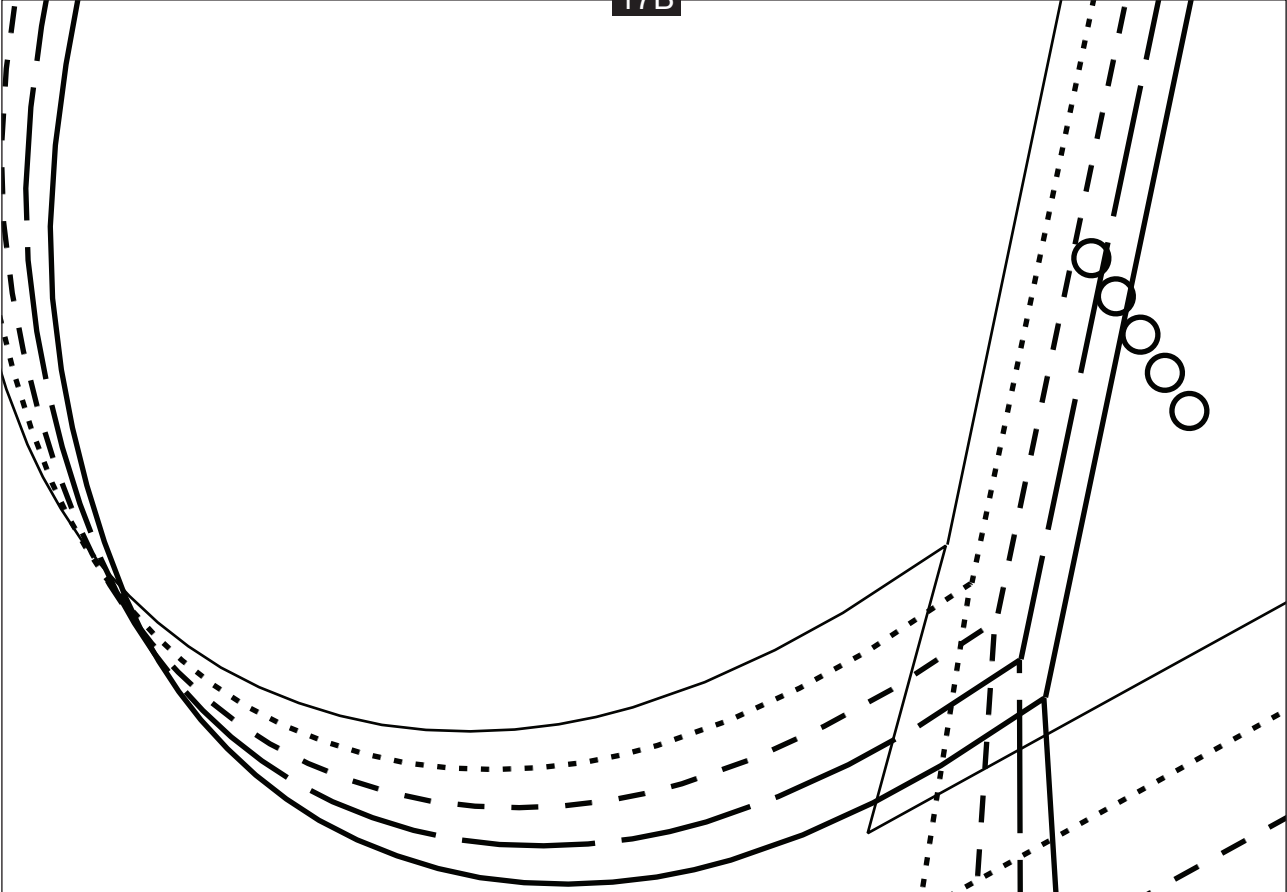

26A

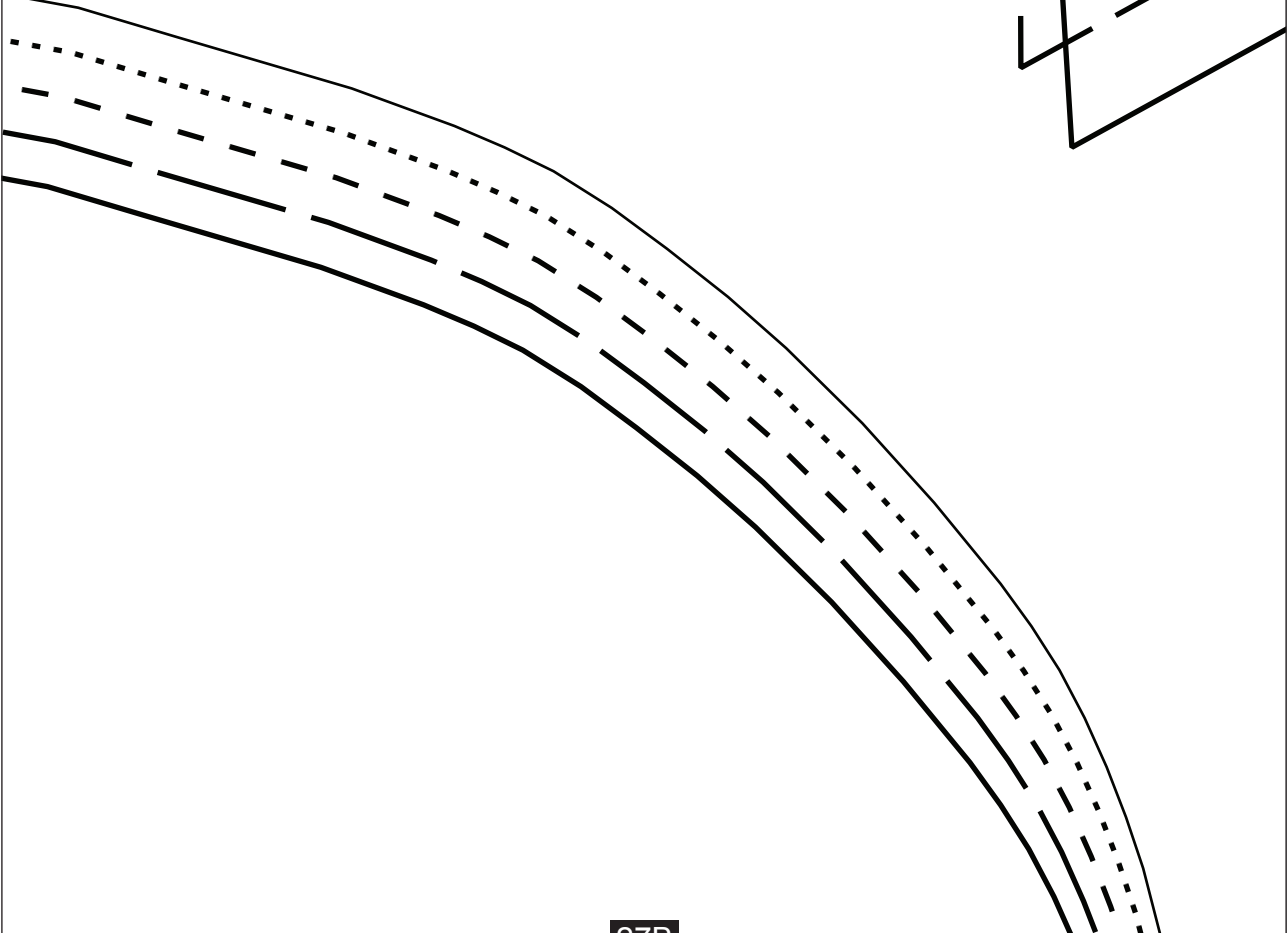

27A

27B

18B

27A

28A

28B

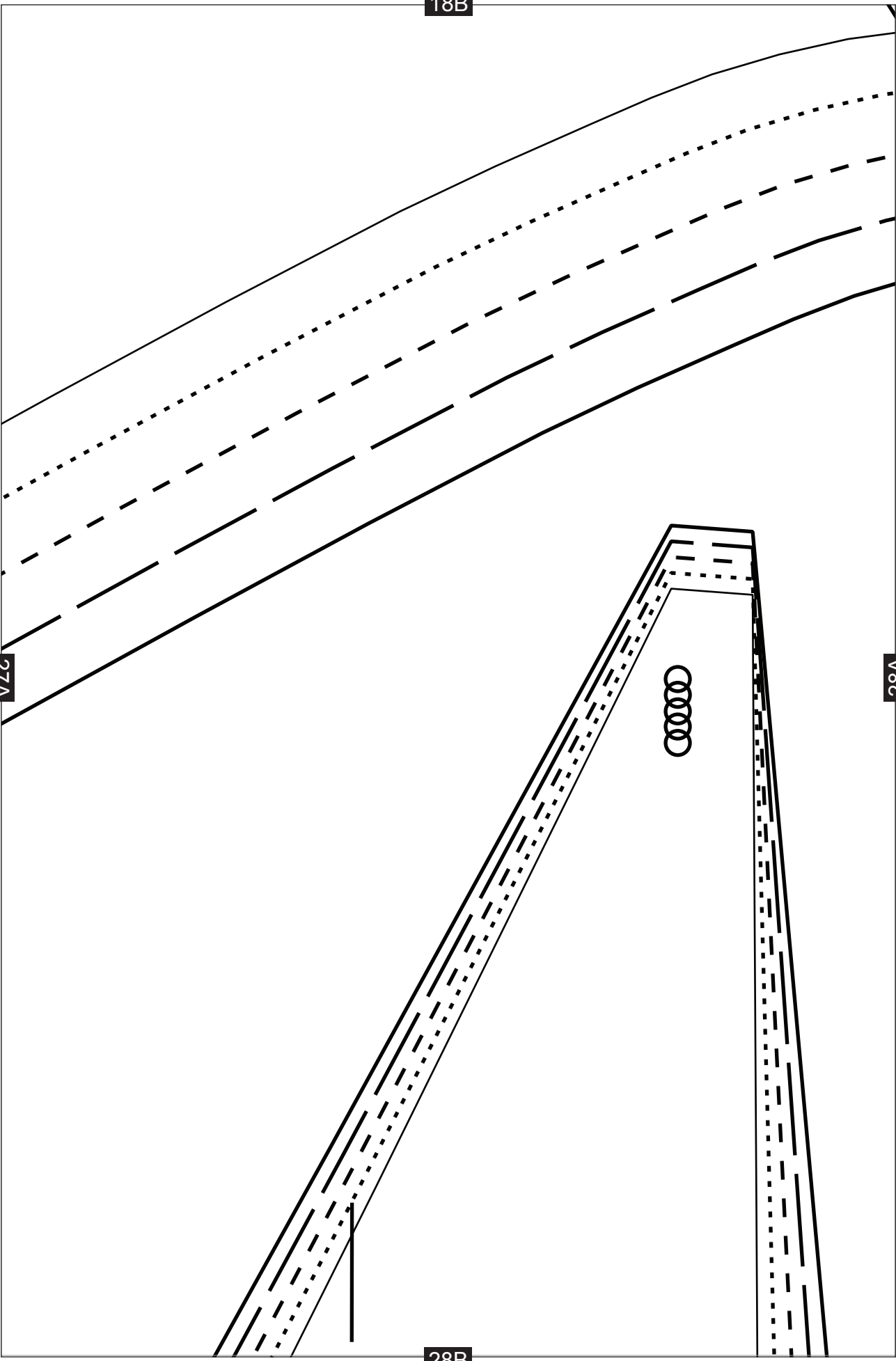

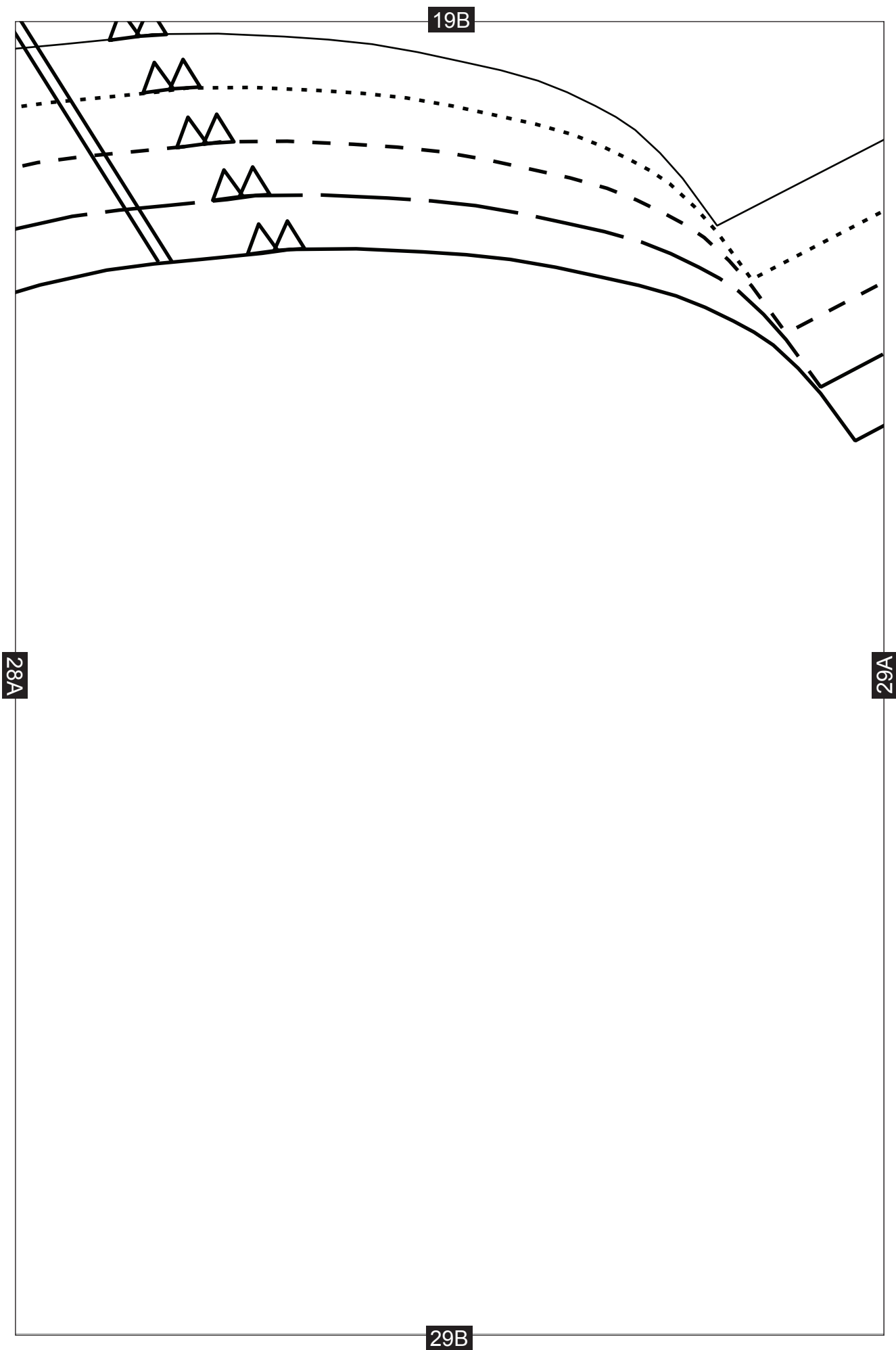

20B

29A

30B

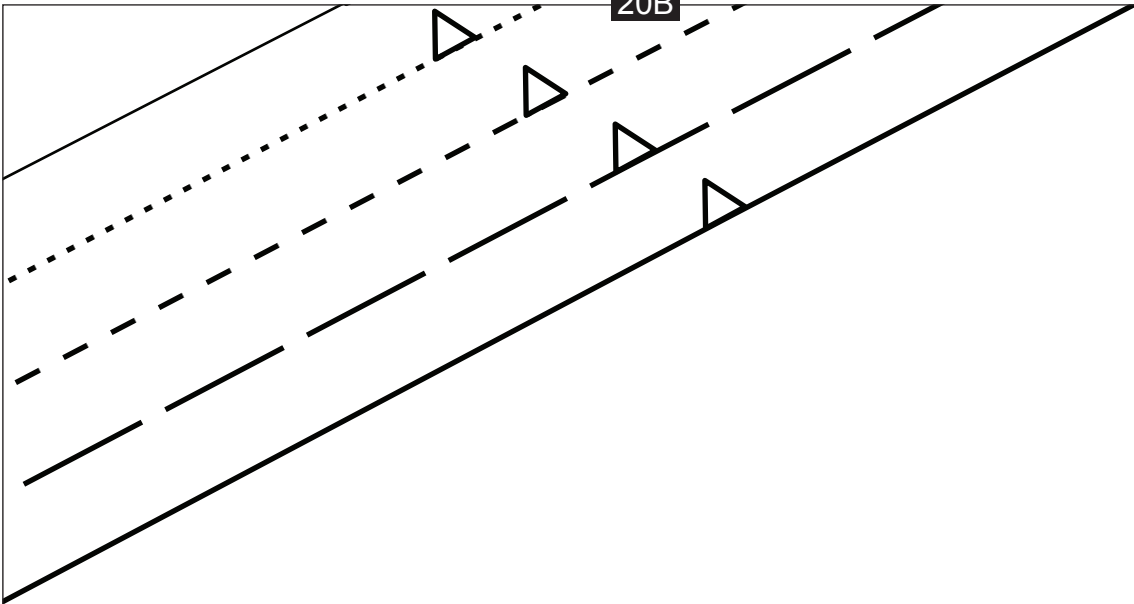

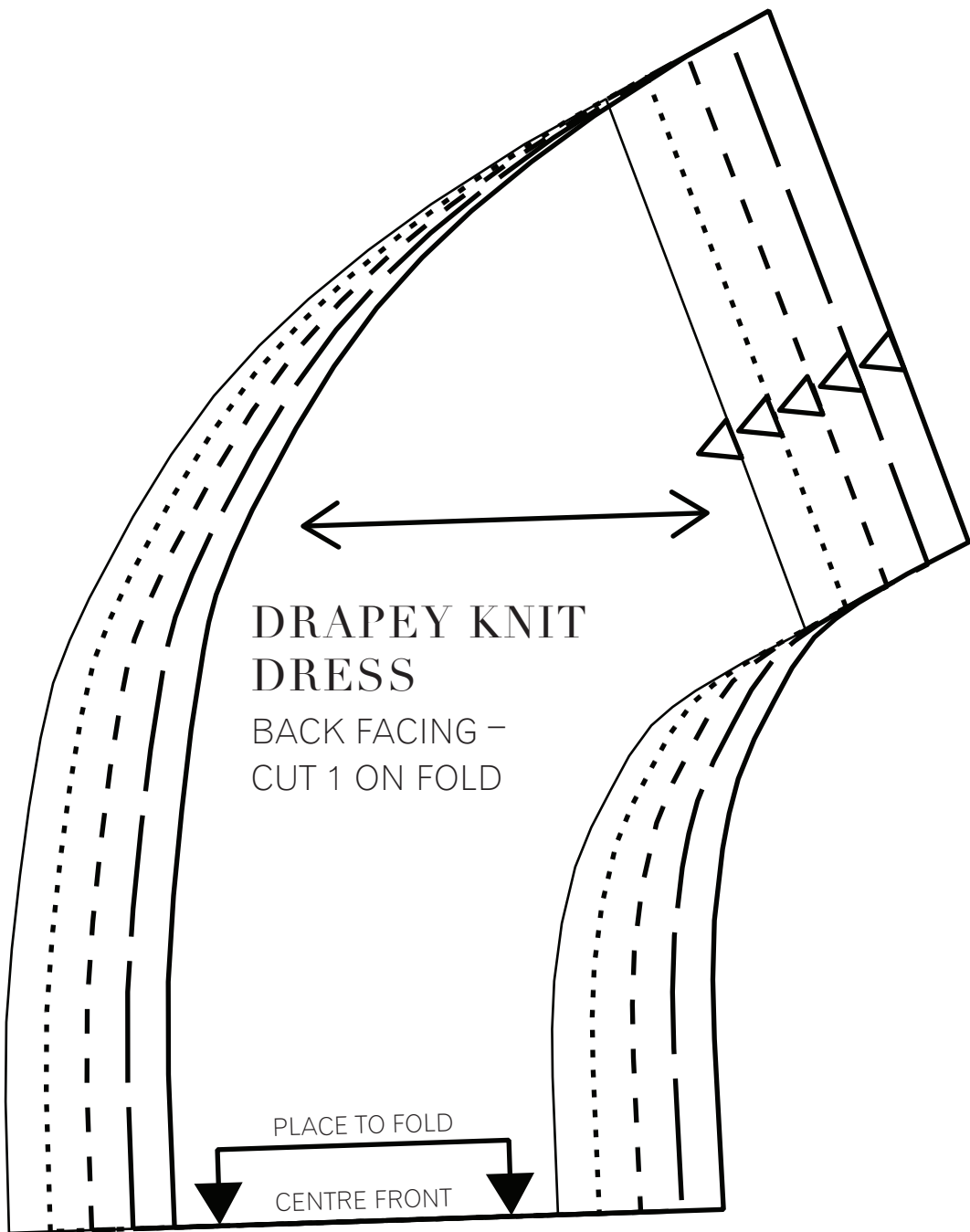

**DRAPEY KNIT  
DRESS**

BACK FACING -  
CUT 1 ON FOLD

PLACE TO FOLD

CENTRE FRONT

22B

31A

32A

32B

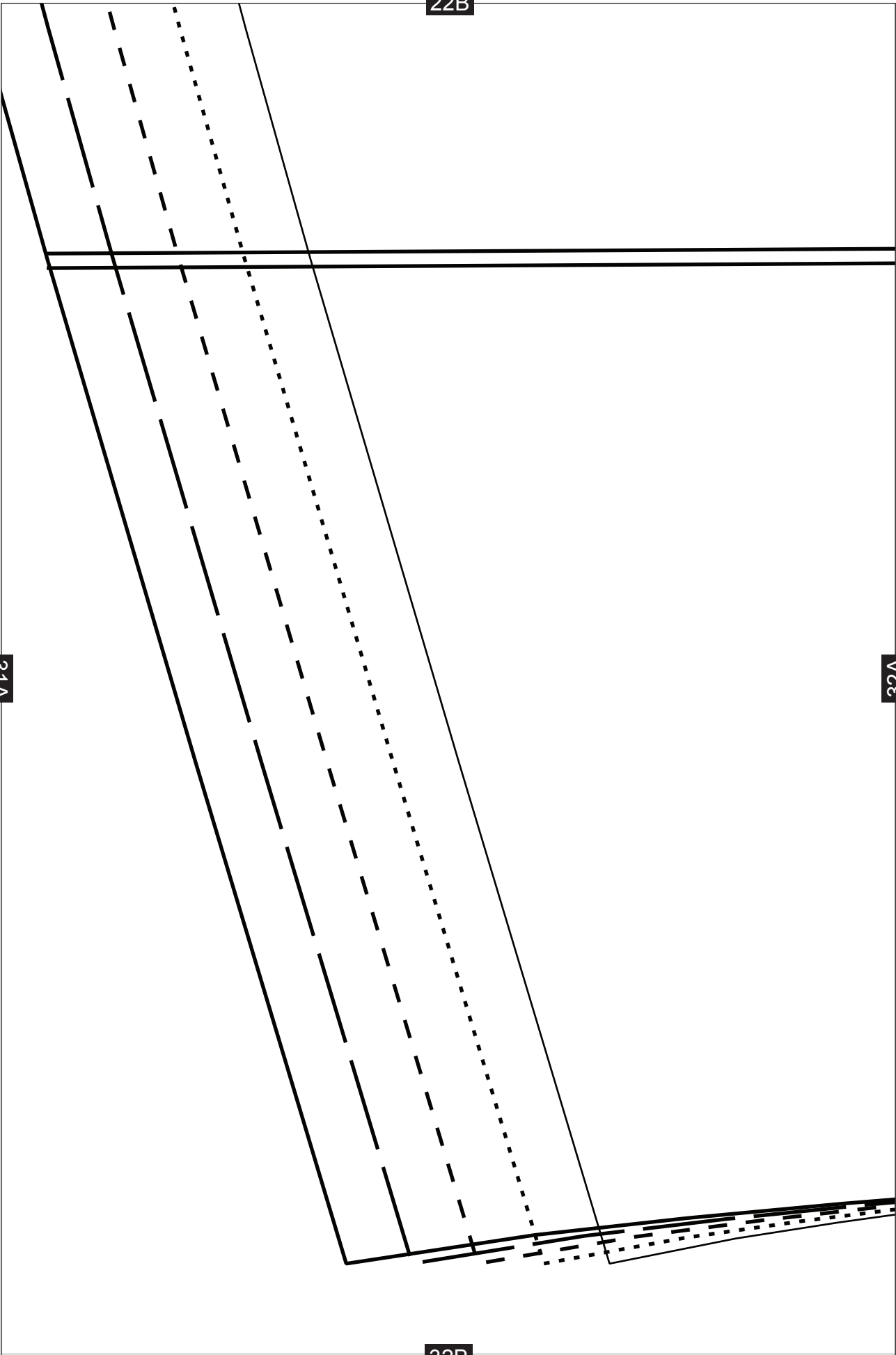



23B

SHORTEN OR LENGTHEN HERE

32A

33A

2.5-CM (1-IN) HEM INCLUDED

33B

24B

STRETCH

33A

34A

XS

S

M

L

XL

34B

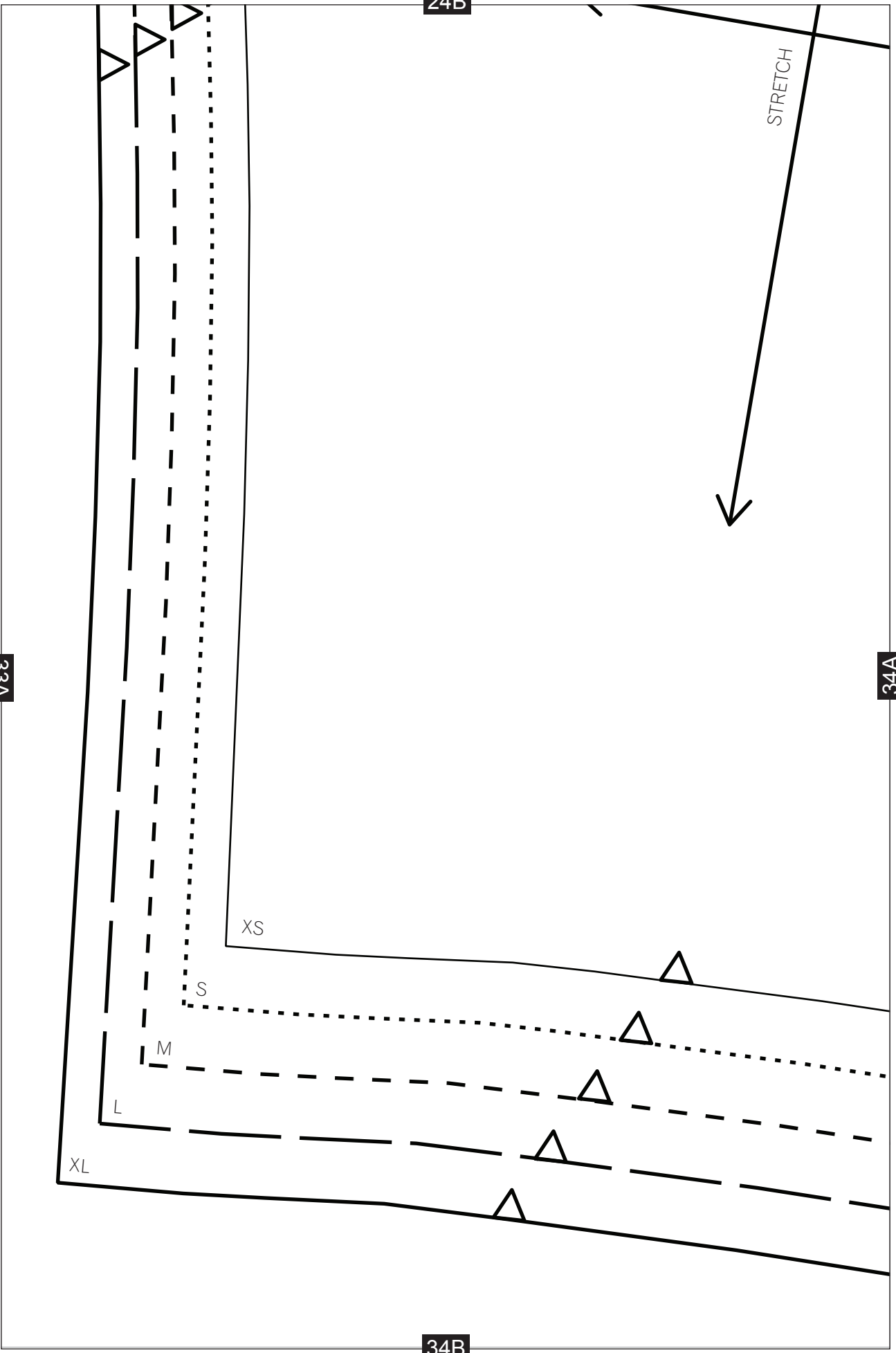

25B

GRAINLINE



34A

35A

35B

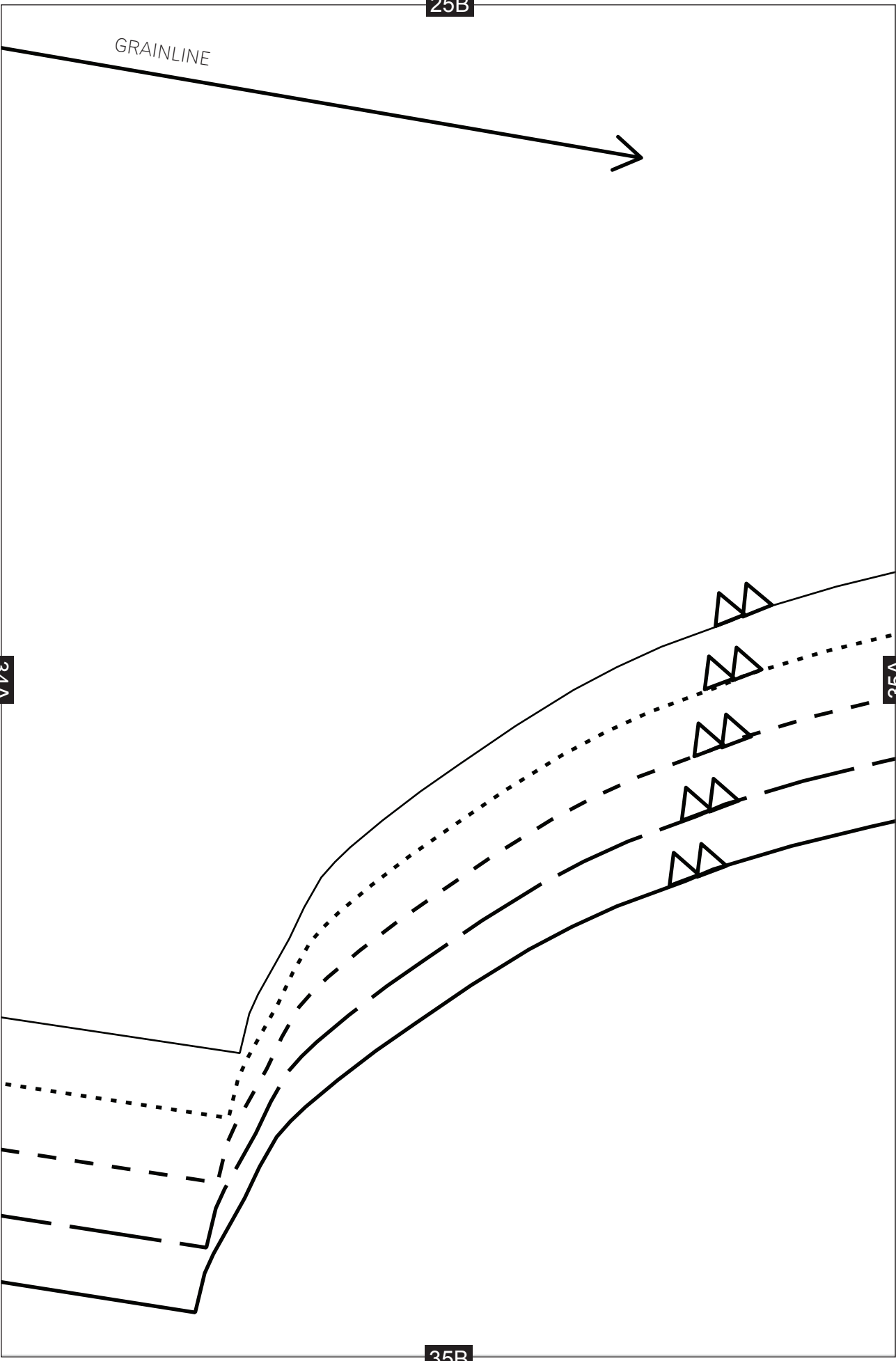

26B

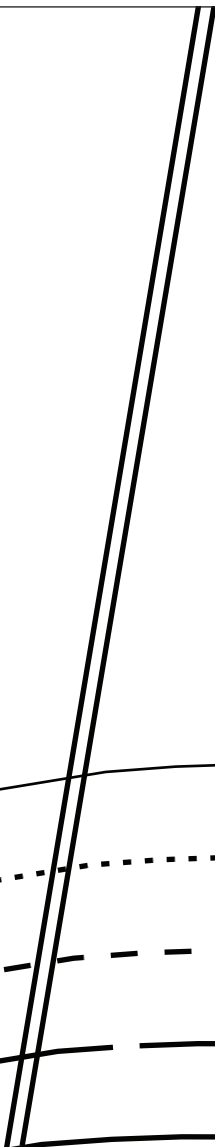
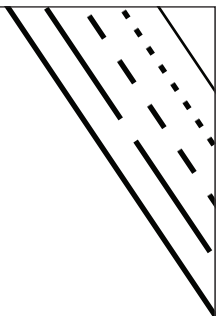

35A

36A

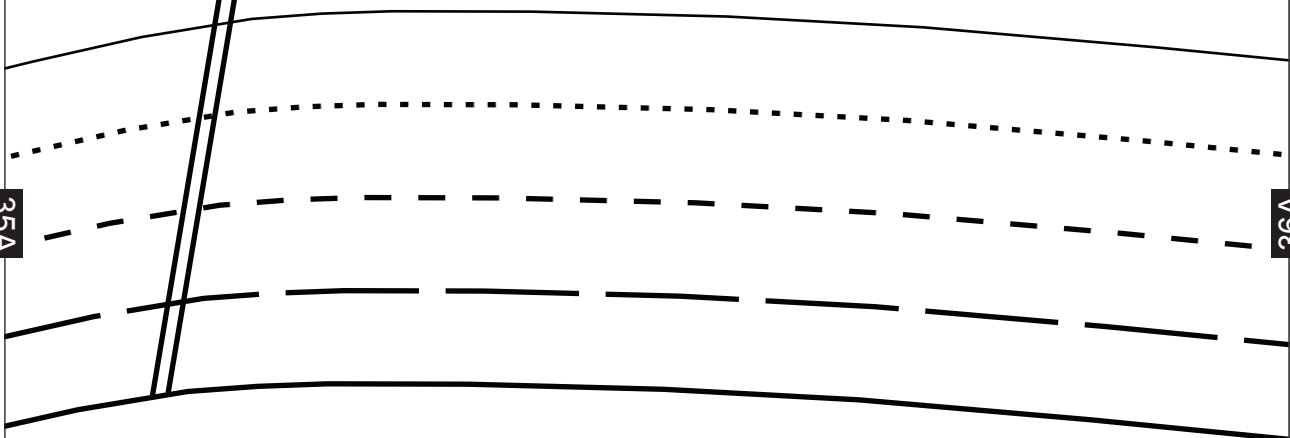

36B

27B

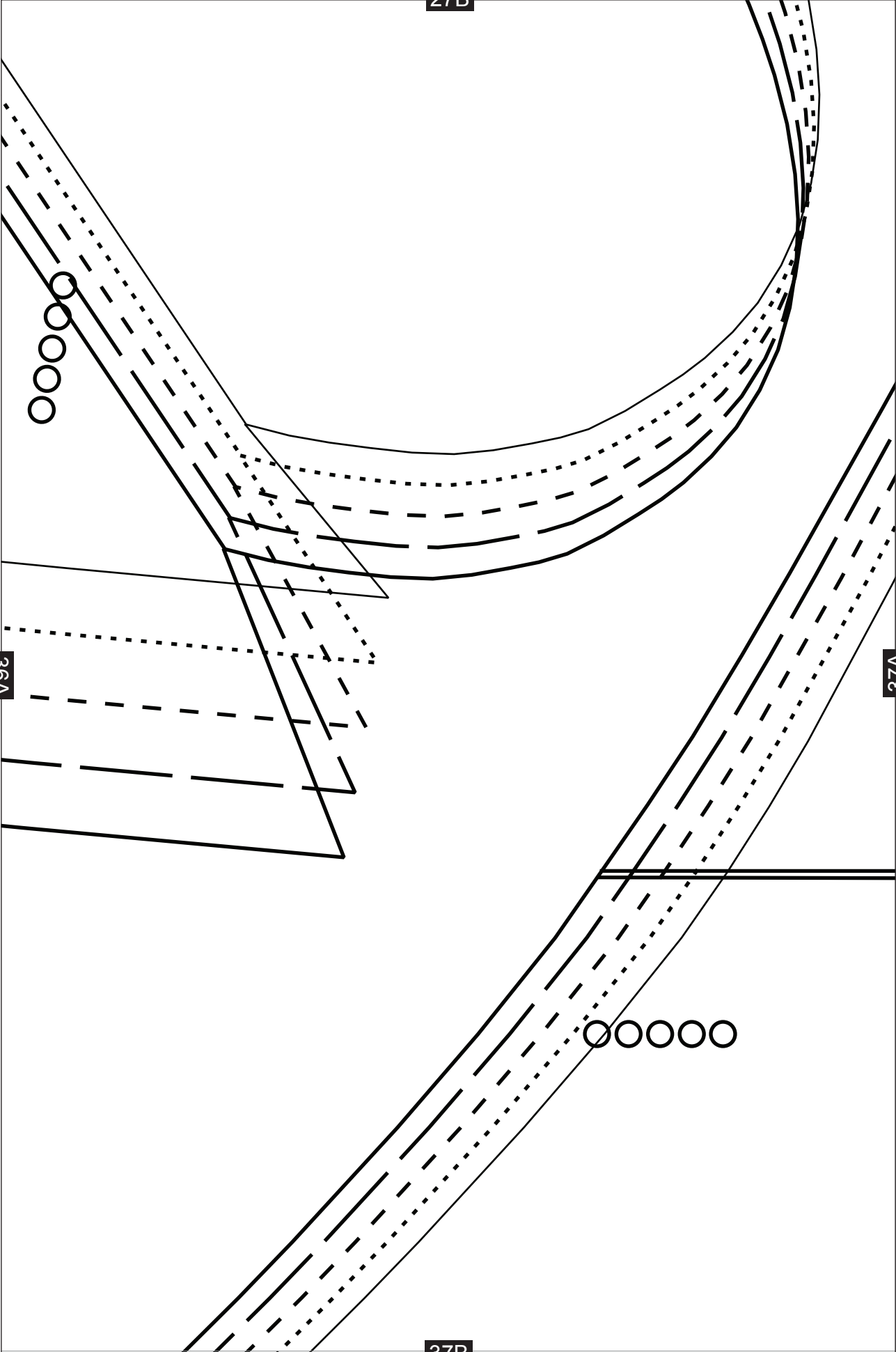

36A

37A

37B

28B

37A

38A

OOOQQ

SHORTEN OR LENGTHEN HERE

38B

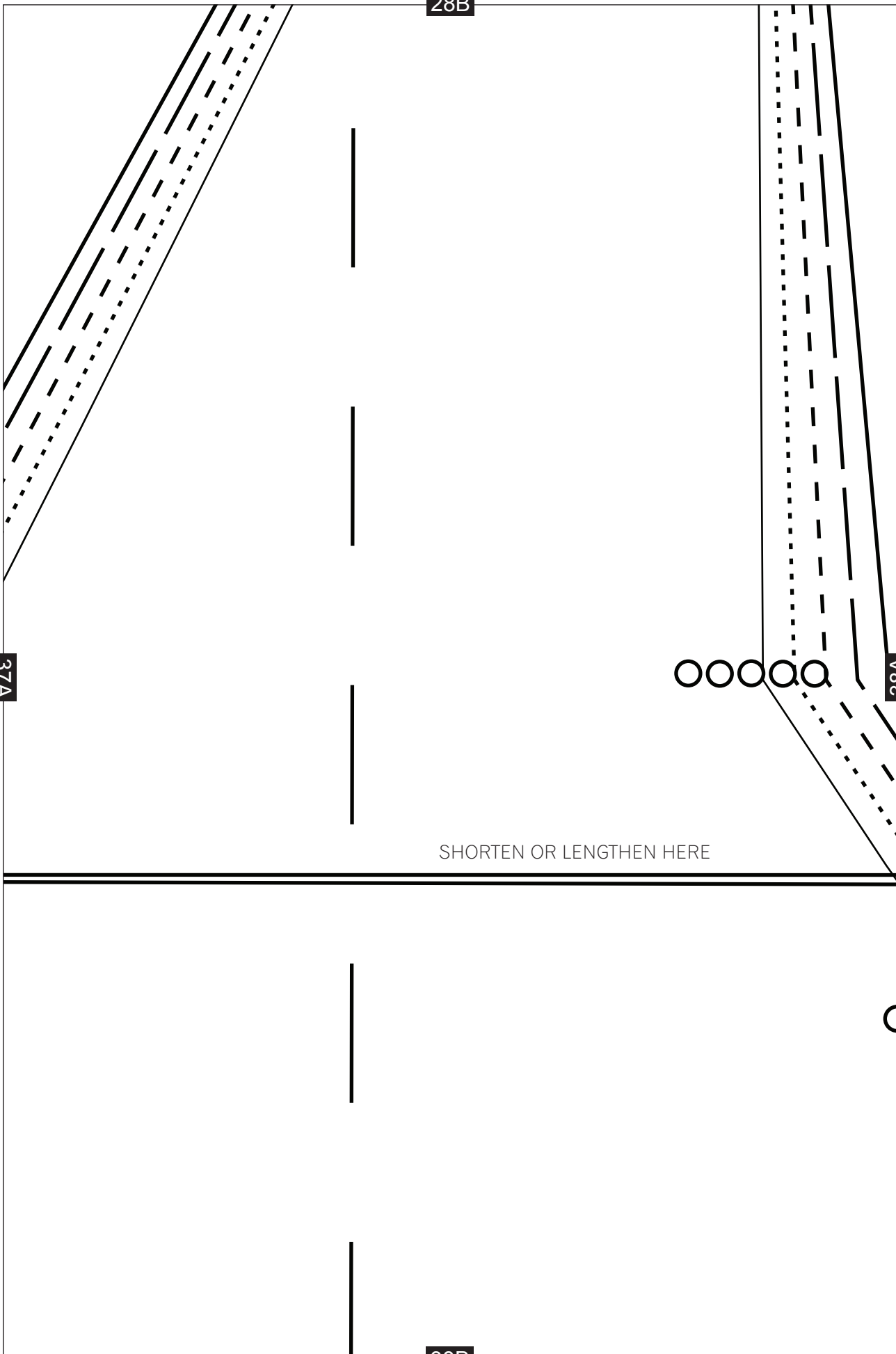

29B

39A

38A

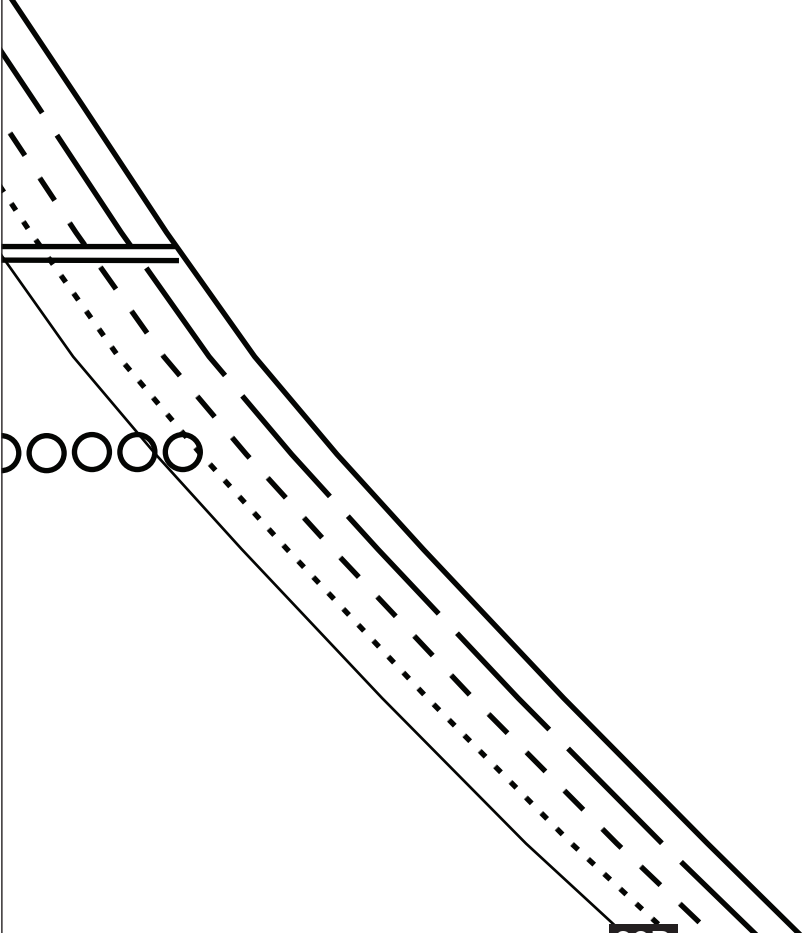

39B

30B

39A

40B



36B

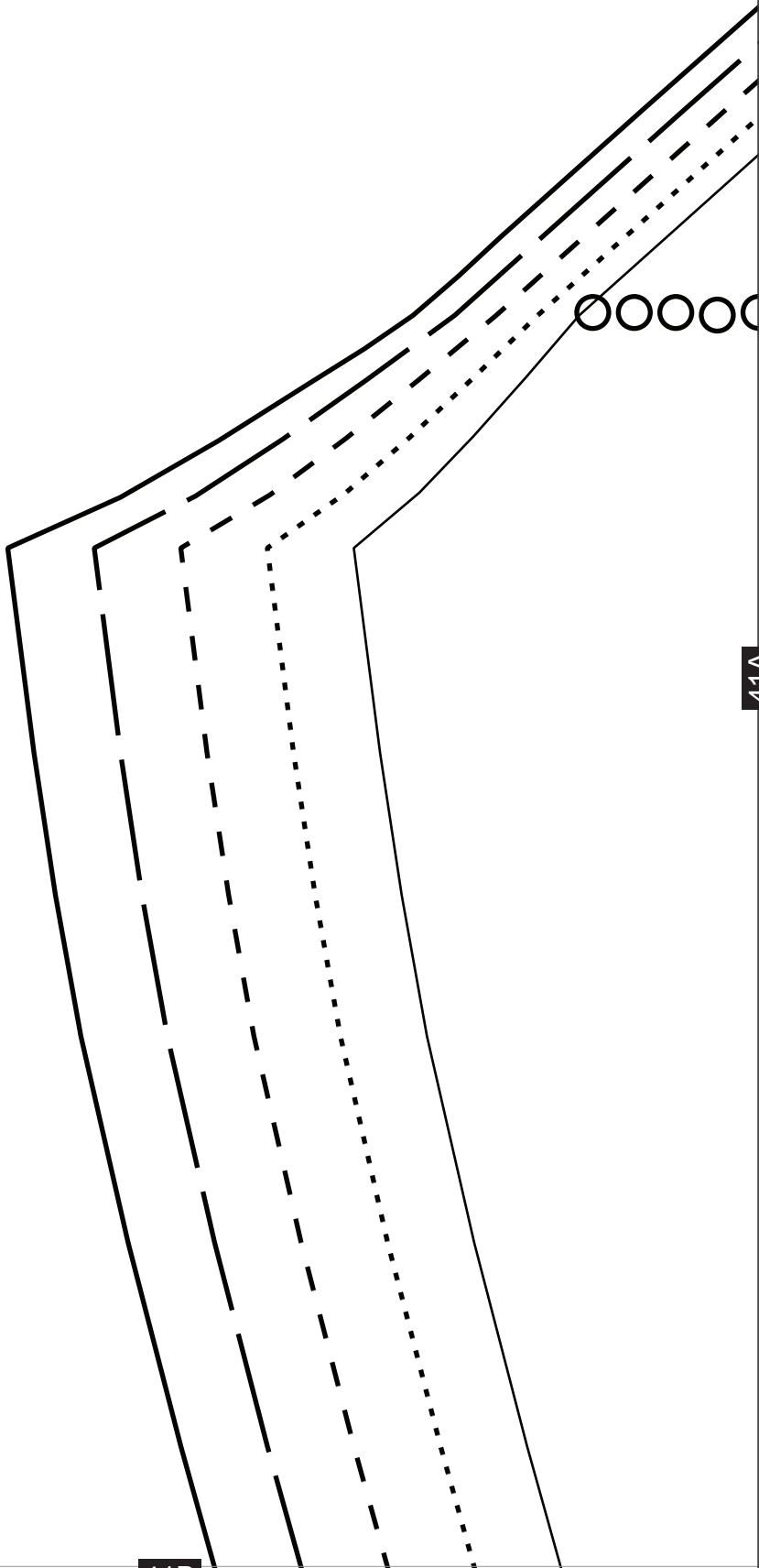

41A

41B

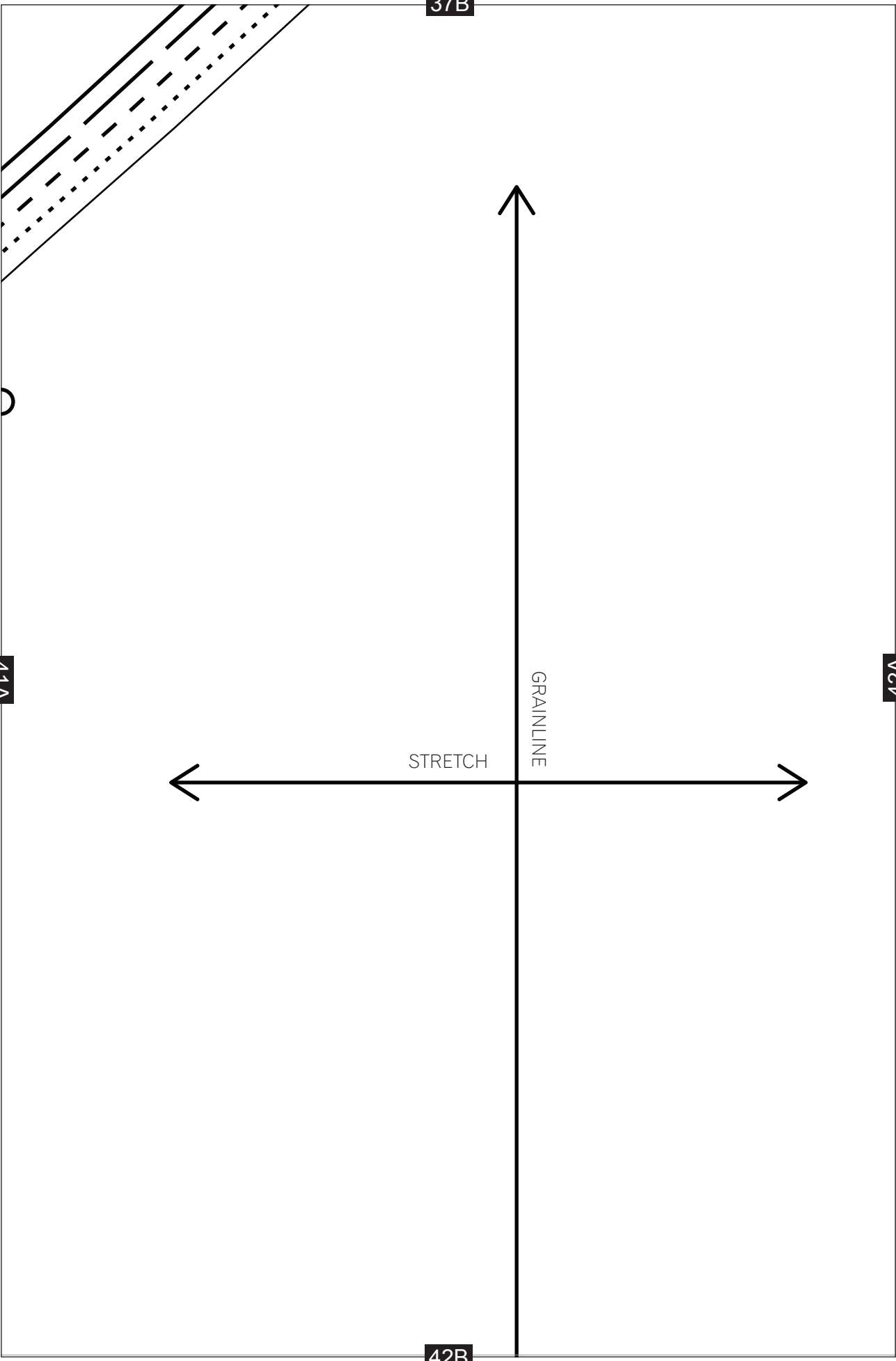

38B

42A

43A

43B

39B

POCKET OPENING



43A

44A

# DRAPEY KNIT DRESS

FRONT CENTRE - CUT 1

44B

40B

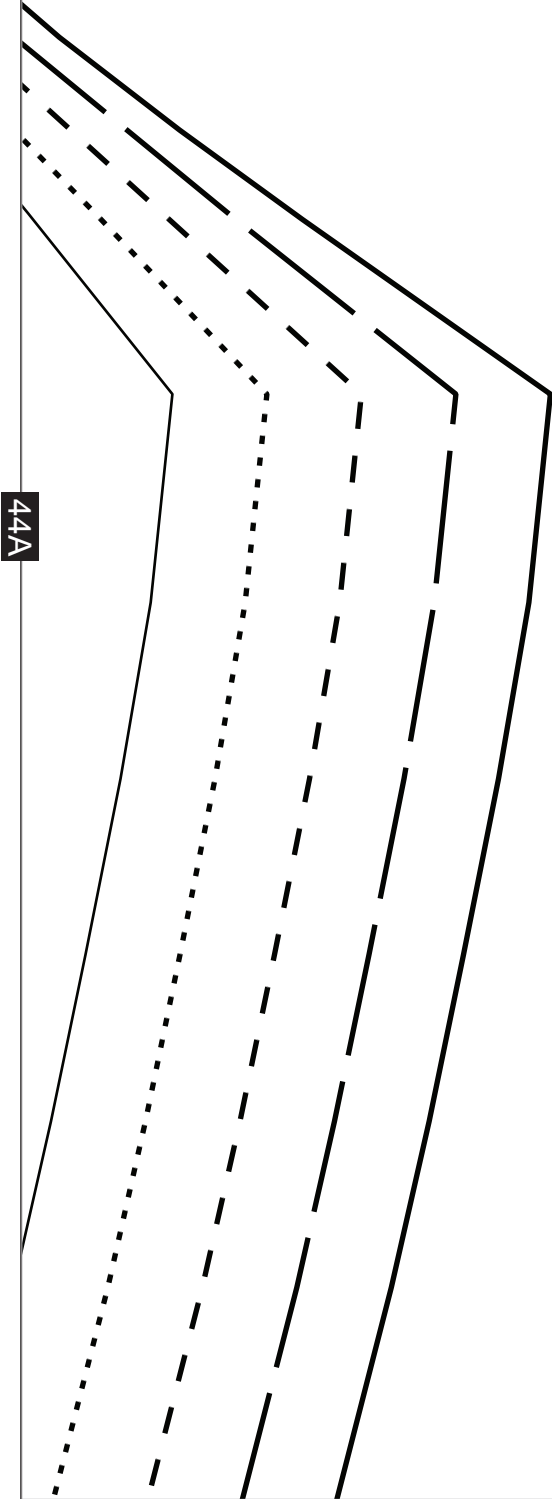

44A

45B

41B

46A

46B

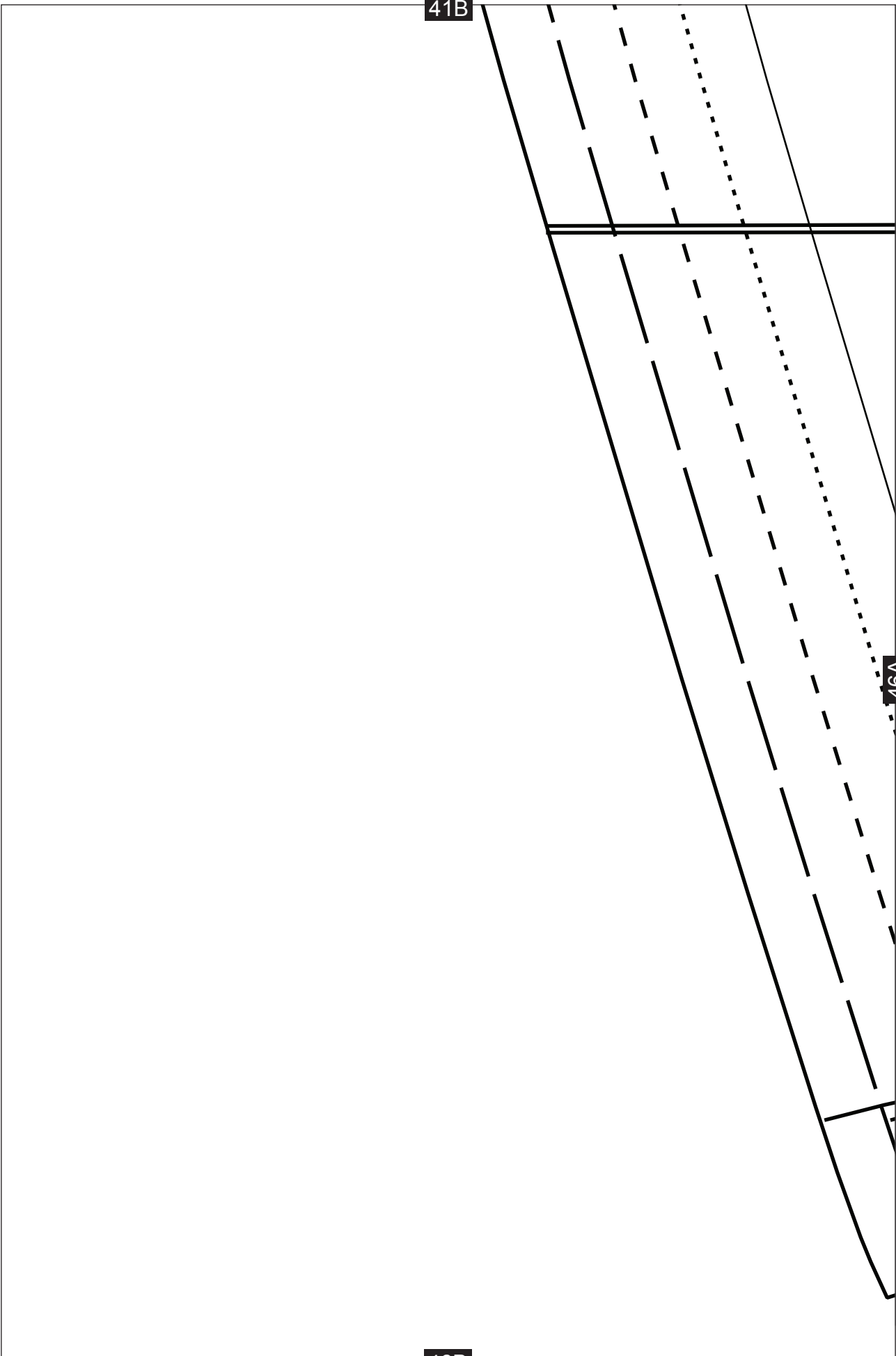

42B

46A

47A

47B

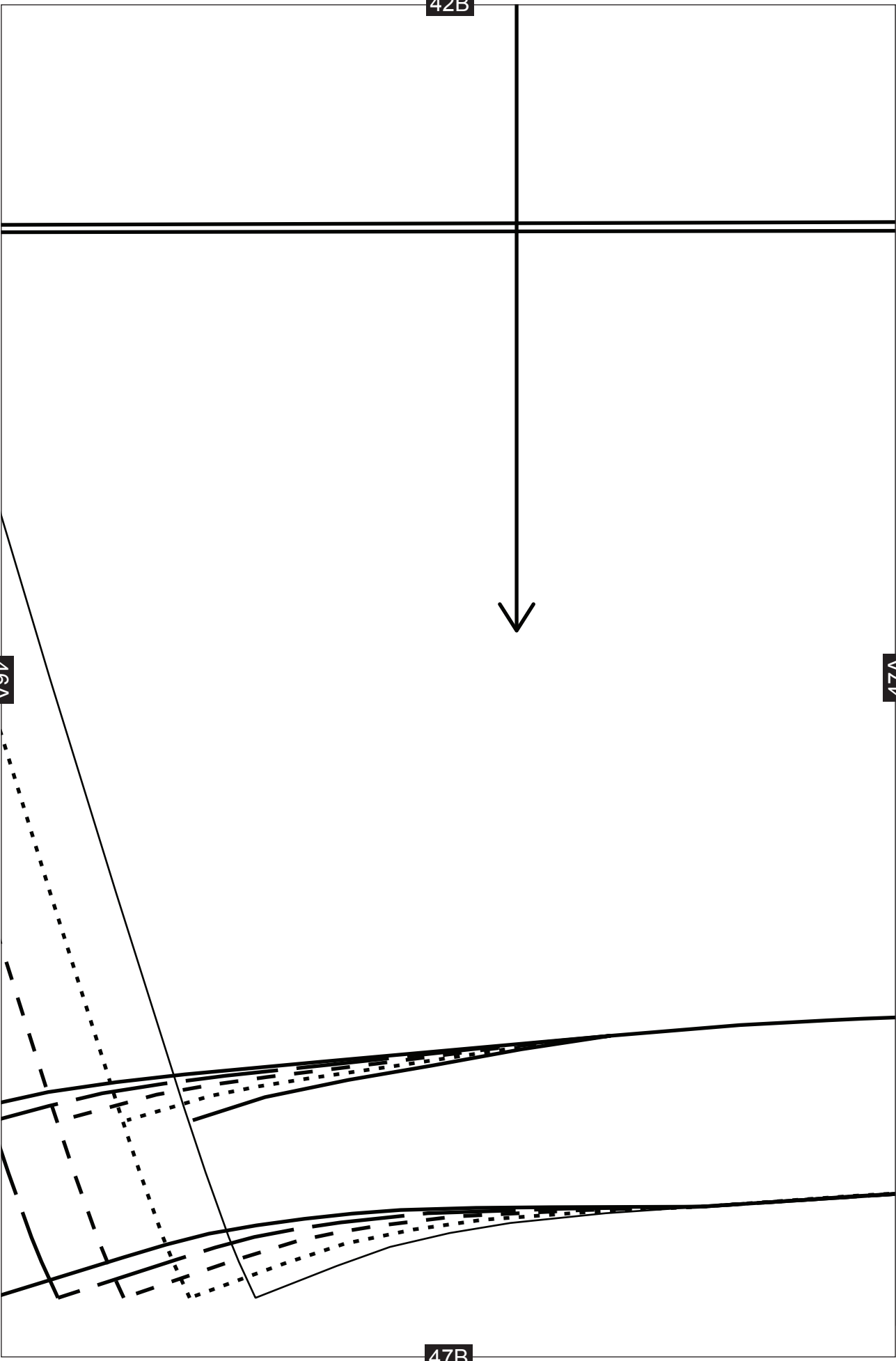

43B

SHORTEN OR LENGTHEN HERE

CENTRE FRONT LINE

47A

48A

OPTIONAL CUT LINE

48B

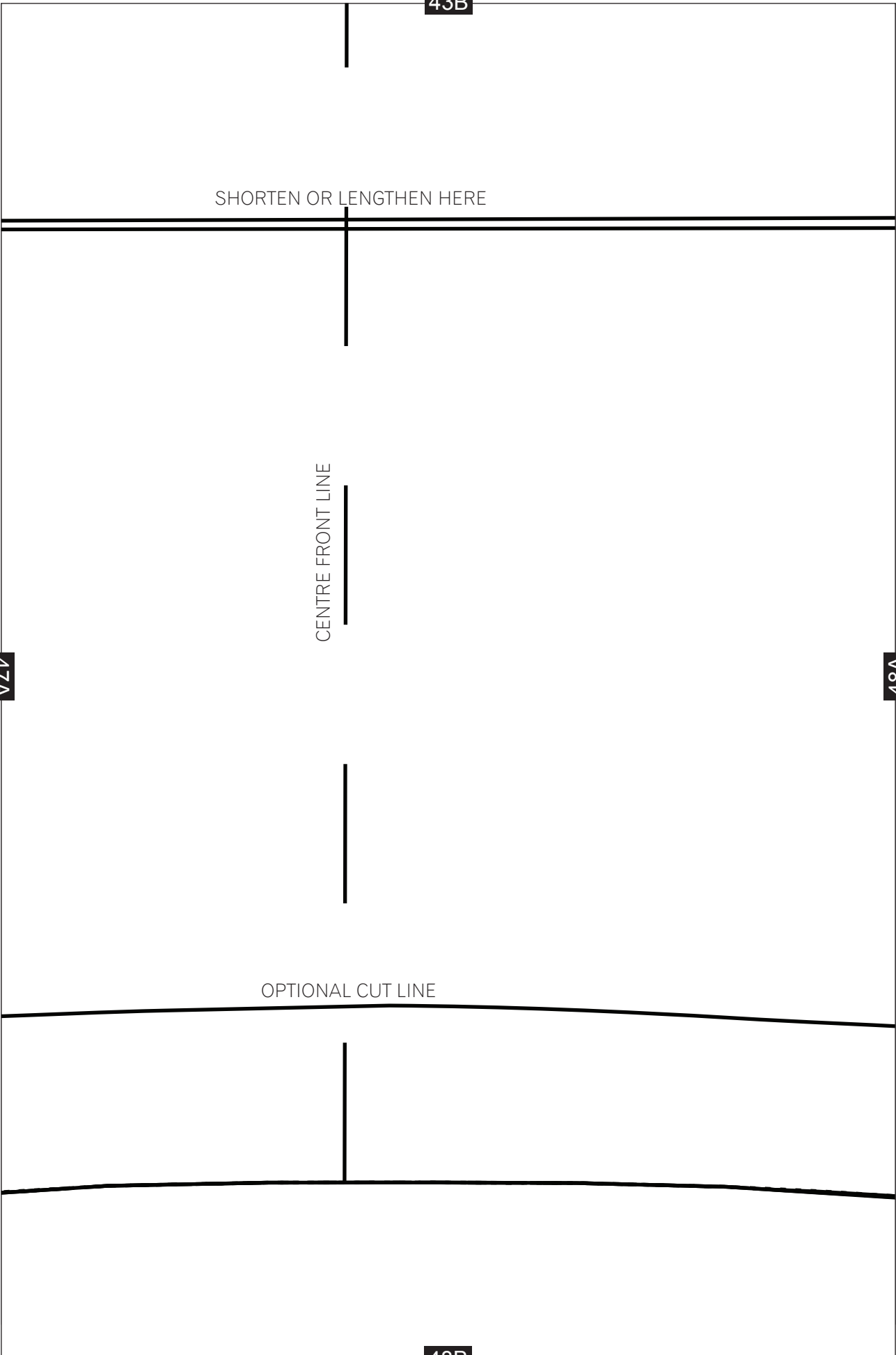



44B

48A

49A

49B

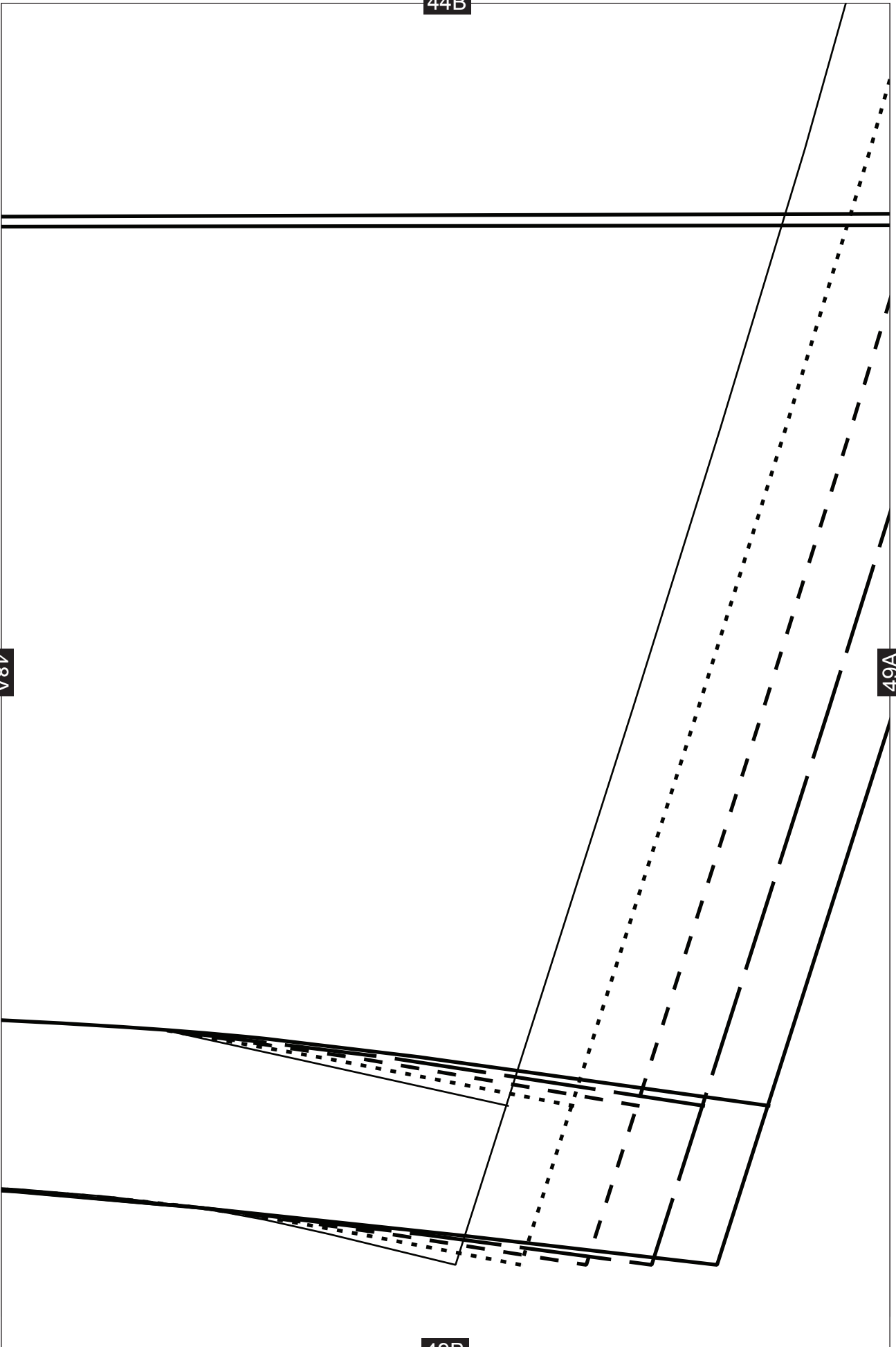

45B

49A

50B

